

MONTAGE PLUS[®]



ORNAMENTAL STEEL FENCE

Montage Plus ornamental steel fence has the *versatility to fit many different project applications*. With its ability to *traverse varying grades*, variety of *distinct product styles* and unmatched coating performance, Montage Plus is the *preferred choice for ornamental fence*.



PRIMARY APPLICATIONS

- ***Commercial Developments***
- ***Self Storage***
- ***Apartments (Multi-Family)***
- ***Parks & Recreation***
- ***Schools & Universities***



AMERISTARFENCE.COM | 888-333-3422

ASSA ABLOY, the global leader in door opening solutions

AMERISTAR[®]
ASSA ABLOY

MONTAGE PLUS[®]

ORNAMENTAL STEEL FENCE

.75"sq x 18ga PICKETS | 1.4375" x 1.5" x 14ga RAILS | 2.5"sq x 16ga POSTS

Each picket is precisely welded at each rail intersection providing all-terrain flexibility and aesthetics.

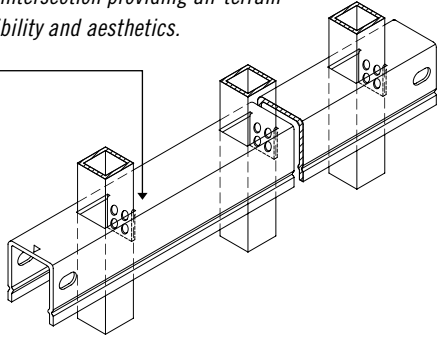

STYLE OPTIONS



Also available in Pool, Pet & Play (3" air spacing) – styles vary

PROFUSION WELDED STEEL



All Montage fence panels are fabricated using Ameristar's ProFusion welding process. This technique combines laser and fusion technology to create a virtually invisible structural connection at every picket to rail intersection. Unlike typical aluminum fence systems that are held together with unsightly screws, the ProFusion weld used with Montage promotes a "good neighbor" profile with sleek lines and no exposed picket to rail fasteners. When compared to aluminum fencing, Montage's welded steel construction is unmatched in strength and durability.



E-COAT™ PROTECTIVE FINISH

Montage galvanized steel framework is subjected to a multi-stage pre-treatment/wash (with zinc phosphate), followed by a duplex cathodic electrocoat system consisting of an epoxy primer, which significantly increases corrosion protection, and an acrylic topcoat, which provides the protection necessary to withstand adverse weathering effects. This process results in years of maintenance-free ownership.



20 YEAR LIMITED WARRANTY

The Montage families of fencing products are manufactured from superior quality materials by skilled craftsmen with the highest standards of workmanship in the industry. Ameristar is confident in offering Montage with a 20 year limited warranty.



DOMESTIC MANUFACTURING

Ameristar is committed to providing products that are manufactured in the USA. We have made significant investments in technology, process improvement, and employee training in an effort to secure American jobs and combat inferior import products.



FENCE PRODUCTS

TO PLACE YOUR ORDER CALL 888-333-3422

VISIT AMERISTARFENCE.COM

MONTAGE PLUS® | 2 & 3-RAIL OPTIONS | 3" & 4" AIR-SPACE OPTIONS

STANDARD BOTTOM & FLUSH BOTTOM OPTIONS AVAILABLE

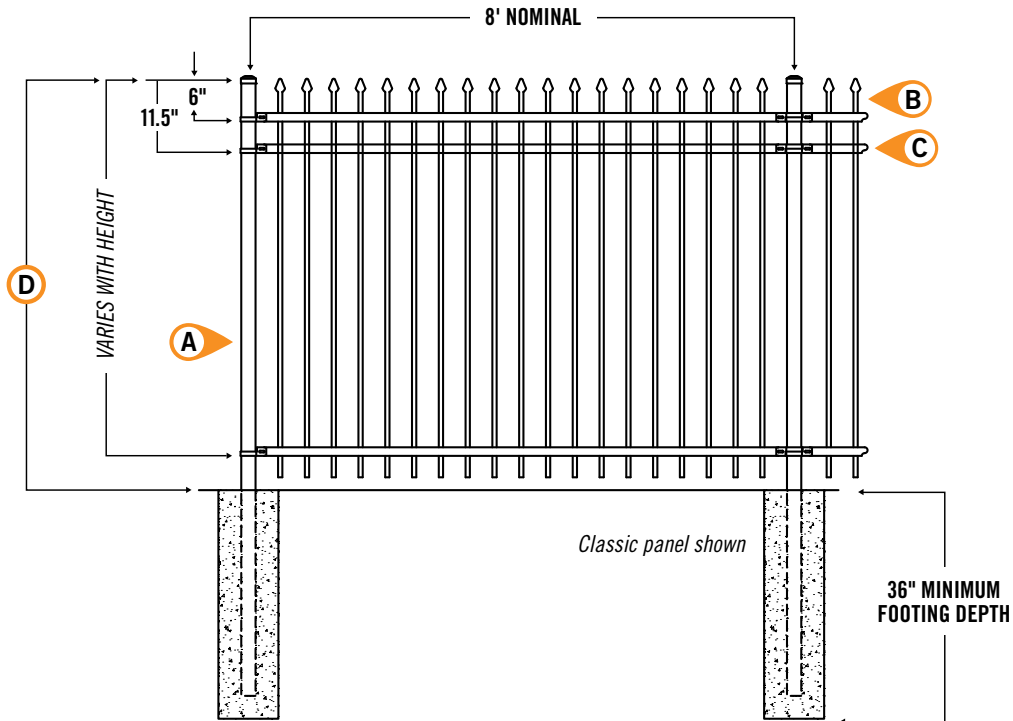

- Ⓐ 2.5"sq x 16ga POSTS
- Ⓑ 0.75"sq x 18ga PICKETS
- Ⓒ 1.4375"w x 1.5"h x 14ga RAILS
- Ⓓ 3', 3.5', 4', 4.5', 5' & 6' PANEL HEIGHTS

Refer to construction specification & tables within this section for recommended post space by bracket type

Effective: 01/06/15

MONTAGE PLUS® | 2-RAIL PANELS | 4" AIR GAP

STANDARD BOTTOM | 8' PANEL LENGTH (92" actual width) | 19 PICKETS PER PANEL | 30 PANELS PER PALLET

PANEL	ITEM NUMBER	WEIGHT	STOCKING
3'	1R☒⊗234	42 lbs	MB
3.5'	1R☒⊗240	48 lbs	MB
4'	1R☒⊗246	52 lbs	MB
5'	1R☒⊗258	61 lbs	CB
6'	1R☒⊗270	70 lbs	CB MB GB

☒ = FENCE STYLES AVAILABLE | **C** = Classic | **M** = Majestic | **G** = Genesis
W = Warrior

⊗ = COLOR OPTIONS AVAILABLE | **B** = Black | **N** = Bronze

⊙ = NON-STOCKED PRODUCT

For details, see Ameristar's Sales Policy in the catalog guide.

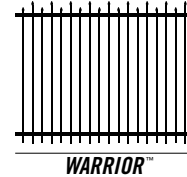
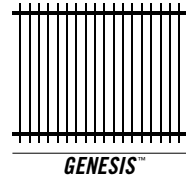
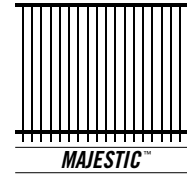
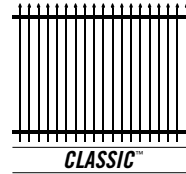

Notes: Genesis panels are packaged with BLACK picket plugs for black & bronze.

MONTAGE PLUS® | 2-RAIL PANELS | 3" AIR GAP

STANDARD BOTTOM | 8' PANEL LENGTH (92" actual width) | 24 PICKETS PER PANEL | 30 PANELS PER PALLET

PANEL	ITEM NUMBER	WEIGHT	STOCKING
3'	1R☒⊗234-3	49 lbs	⊙
3.5'	1R☒⊗240-3	55 lbs	⊙
4'	1R☒⊗246-3	61 lbs	⊙
5'	1R☒⊗258-3	72 lbs	⊙
6'	1R☒⊗270-3	83 lbs	⊙

☒ = FENCE STYLES AVAILABLE | **C** = Classic | **M** = Majestic | **G** = Gemini

⊗ = COLOR OPTIONS AVAILABLE | **B** = Black | **N** = Bronze

⊙ = NON-STOCKED PRODUCT

For details, see Ameristar's Sales Policy in the catalog guide.

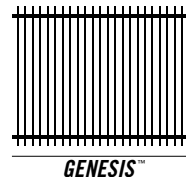
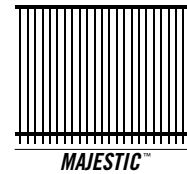
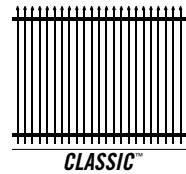

Notes: Genesis panels are packaged with BLACK picket plugs for black & bronze.

Effective: 01/06/15

MONTAGE PLUS® | 2-RAIL PANELS | 4" AIR GAP

FLUSH BOTTOM | 8' PANEL LENGTH (92" actual width) | 19 PICKETS PER PANEL | 30 PANELS PER PALLET

PANEL	ITEM NUMBER	WEIGHT	STOCKING
3'	1R☒⊗234F	42 lbs	<u>MB</u>
3.5'	1R☒⊗240F	48 lbs	<u>MB</u>
4'	1R☒⊗246F	52 lbs	<u>MB</u>
5'	1R☒⊗258F	61 lbs	<u>CB</u>
6'	1R☒⊗270F	70 lbs	<u>MB</u>

☒ = FENCE STYLES AVAILABLE | C = Classic M = Majestic G = Genesis
W = Warrior

⊗ = COLOR OPTIONS AVAILABLE | B = Black N = Bronze

⊙ = NON-STOCKED PRODUCT
 For details, see Ameristar's Sales Policy in the catalog guide.

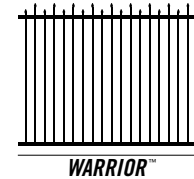
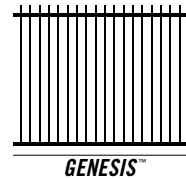
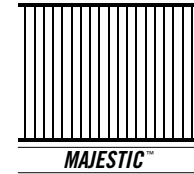
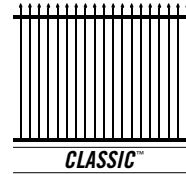

Notes: Genesis panels are packaged with BLACK picket plugs for black & bronze.

MONTAGE PLUS® | 2-RAIL PANELS | 3" AIR GAP

FLUSH BOTTOM | 8' PANEL LENGTH (92" actual width) | 24 PICKETS PER PANEL | 30 PANELS PER PALLET

PANEL	ITEM NUMBER	WEIGHT	STOCKING
3'	1R☒⊗234F-3	49 lbs	⊙
3.5'	1R☒⊗240F-3	55 lbs	⊙
4'	1R☒⊗246F-3	61 lbs	⊙
5'	1R☒⊗258F-3	72 lbs	⊙
6'	1R☒⊗270F-3	83 lbs	⊙

☒ = FENCE STYLES AVAILABLE | C = Classic M = Majestic G = Gemini

⊗ = COLOR OPTIONS AVAILABLE | B = Black N = Bronze

⊙ = NON-STOCKED PRODUCT
 For details, see Ameristar's Sales Policy in the catalog guide.

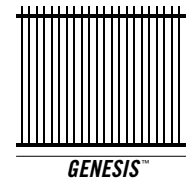
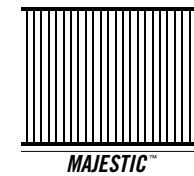
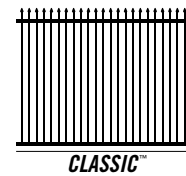

Notes: Genesis panels are packaged with BLACK picket plugs for black & bronze.

Effective: 01/06/15

MONTAGE PLUS® | 3-RAIL PANELS | 4" AIR GAP

STANDARD BOTTOM | 8' PANEL LENGTH (92" actual width) | 19 PICKETS PER PANEL | 30 PANELS PER PALLET

PANEL	ITEM NUMBER	WEIGHT	STOCKING
3'	1R☒☒334	50 lbs	MB
3.5'	1R☒☒340	56 lbs	MB
4'	1R☒☒346	60 lbs	CB MB GB MN
5'	1R☒☒358	69 lbs	CB MB GB
6'	1R☒☒370	78 lbs	CB MB GB MN

☒ = FENCE STYLES AVAILABLE | **C** = Classic **M** = Majestic **G** = Genesis
W = Warrior

☒ = COLOR OPTIONS AVAILABLE | **B** = Black **N** = Bronze

⊙ = NON-STOCKED PRODUCT

For details, see Ameristar's Sales Policy in the catalog guide.

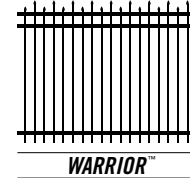
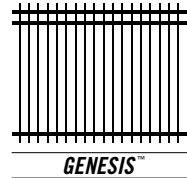
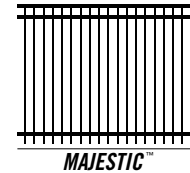
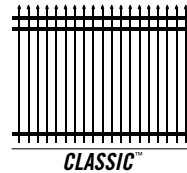

Notes: Genesis panels are packaged with BLACK picket plugs for black & bronze.

MONTAGE PLUS® | 3-RAIL PANELS | 3" AIR GAP

STANDARD BOTTOM | 8' PANEL LENGTH (92" actual width) | 24 PICKETS PER PANEL | 30 PANELS PER PALLET

PANEL	ITEM NUMBER	WEIGHT	STOCKING
3'	1R☒☒334-3	56 lbs	⊙
3.5'	1R☒☒340-3	63 lbs	⊙
4'	1R☒☒346-3	69 lbs	⊙
5'	1R☒☒358-3	80 lbs	⊙
6'	1R☒☒370-3	91 lbs	⊙

☒ = FENCE STYLES AVAILABLE | **C** = Classic **M** = Majestic **G** = Genesis

☒ = COLOR OPTIONS AVAILABLE | **B** = Black **N** = Bronze

⊙ = NON-STOCKED PRODUCT

For details, see Ameristar's Sales Policy in the catalog guide.

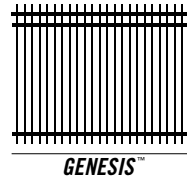
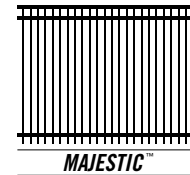
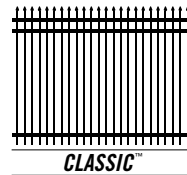

Notes: Genesis panels are packaged with BLACK picket plugs for black & bronze.

Effective: 01/06/15

MONTAGE PLUS® | 3-RAIL PANELS | 4" AIR GAP

FLUSH BOTTOM | 8' PANEL LENGTH (92" actual width) | 19 PICKETS PER PANEL | 30 PANELS PER PALLET

PANEL	ITEM NUMBER	WEIGHT	STOCKING
3'	1R☒☒334F	50 lbs	☉
3.5'	1R☒☒340F	56 lbs	<u>MB</u>
4'	1R☒☒346F	60 lbs	<u>MB</u>
4.5'	1RM☒354F	65 lbs	<u>MB</u>
5'	1R☒☒358F	69 lbs	☉
6'	1R☒☒370F	78 lbs	<u>MB</u>

☒ = FENCE STYLES AVAILABLE | C = Classic M = Majestic G = Genesis
W = Warrior

☒ = COLOR OPTIONS AVAILABLE | B = Black N = Bronze

☉ = NON-STOCKED PRODUCT
 For details, see Ameristar's Sales Policy in the catalog guide.

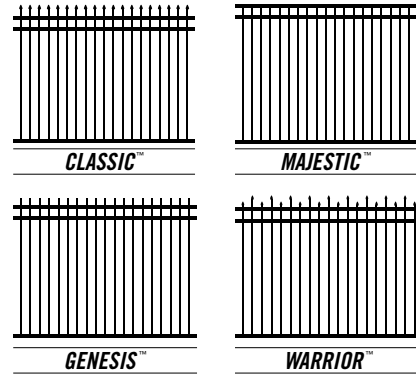

Notes: Genesis panels are packaged with BLACK picket plugs for black & bronze.

MONTAGE PLUS® | 3-RAIL PANELS | 3" AIR GAP

FLUSH BOTTOM | 8' PANEL LENGTH (92" actual width) | 24 PICKETS PER PANEL | 30 PANELS PER PALLET

PANEL	ITEM NUMBER	WEIGHT	STOCKING
3'	1R☒☒334F-3	56 lbs	<u>MB</u>
3.5'	1R☒☒340F-3	63 lbs	☉
4'	1R☒☒346F-3	69 lbs	<u>MB</u>
4.5'	1RM☒354F-3	75 lbs	<u>MB</u>
5'	1R☒☒358F-3	80 lbs	☉
6'	1R☒☒370F-3	91 lbs	<u>MB</u>

☒ = FENCE STYLES AVAILABLE | C = Classic M = Majestic G = Genesis

☒ = COLOR OPTIONS AVAILABLE | B = Black N = Bronze

☉ = NON-STOCKED PRODUCT
 For details, see Ameristar's Sales Policy in the catalog guide.

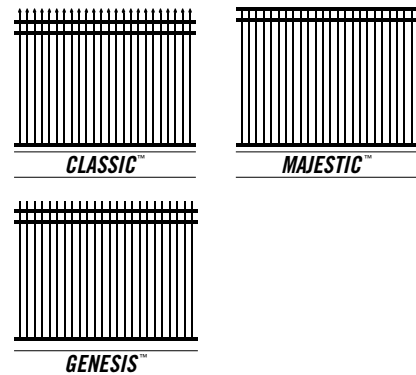

Notes: Genesis panels are packaged with BLACK picket plugs for black & bronze.

Effective: 01/06/15

MONTAGE PLUS® | BRACKETS

AVAILABLE IN BAG QUANTITIES ONLY

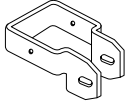

DESCRIPTION	SIZE	ITEM NUMBER	BAG QTY	BOX QTY	WEIGHT
Universal Boulevard Bracket	2.5"	B⊗ 112S	2	80	.15 lbs
	2"	B⊗ 117S	2	120	.15 lbs

Bags packaged with: #14 x .75" self-drilling screws | .25" x 1.75" carriage bolts | .25" tee nuts

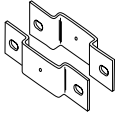

Line Bracket	2.5"	B⊗ 114S	2	80	.84 lbs
	2"	B⊗ 116S	2	100	.72 lbs

Bags packaged with: #14 x .75" self-drilling screws | .25" x 1.75" carriage bolts | .25" tee nuts

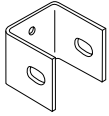

Flat Mount Bracket	n/a	B⊗ 111S	2	204	.27 lbs
--------------------	-----	---------	---	-----	---------

Bags packaged with:
 #14 x .75" self-drilling screws | .25" x 1.75" carriage bolts | .25" tee nuts

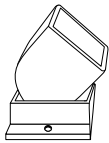

Swivel Bracket	n/a	B⊗ 113	2	80	.20 lbs
----------------	-----	--------	---	----	---------

Bags packaged with: #10 x .75" self-drilling screws | #10 x .625" Phillips flat head screws

⊗ = COLOR OPTIONS AVAILABLE | B = Black N = Bronze

MONTAGE PLUS® | FINIALS & ADORNMENTS

FINIALS & PICKET PLUGS FOR GENESIS PANELS ONLY | ADORNMENTS FOR 4" AIR-SPACE ONLY



QUAD FLARE
 .75" / .15 lbs
 A⊗ 518



TRIAD
 .75" / .15 lbs
 A⊗ 520R



ROYALTY
 .75" / .21 lbs
 A⊗ 525

.625" PRESS FIT PICKET FINIALS

» 19 finials required per panel with 4" air-space

» 24 finials required per panel with a 3" air-space

⊗ = COLOR OPTIONS AVAILABLE | B = Black N = Bronze

NOTE: Picket plugs are available in bag quantities only / 21 plugs per bag: Item number = 8452

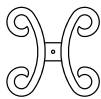

BUTTERFLY SCROLL
 .75" / .7 lbs
 H⊗ 506

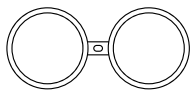

DOUBLE RINGS
 .75" / .2 lbs
 A⊗ 112

MONTAGE PLUS PANEL ADORNMENTS

» Fit in between / on the face of top rails on 3-rail panels

» #10 x .75" self-drilling screws included

» 9 adornments required per panel



» Die cast aluminum

⊗ = COLOR OPTIONS AVAILABLE | B = Black N = Bronze

Effective: 01/06/15

MONTAGE PLUS® | FASTENERS

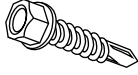
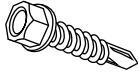
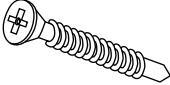
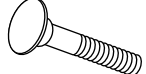
AVAILABLE IN BAG QUANTITIES ONLY (Phillips head screws sold individually)

	DESCRIPTION	ITEM NUMBER / BLACK	ITEM NUMBER / BRONZE	BAG QTY	WEIGHT EA
	#14 x .75" Self-Drilling Screws <i>Steel hex head self-drilling screws for attaching Montage Plus brackets & adornments</i>	1-0004-1P-50	1-0004-2P-50	50	.6 lbs
	#10 x .625" Self-Drilling Screws <i>Steel hex head self-drilling screws for attaching Montage Plus brackets & adornments</i>	1-0002-1P-50	1-0002-2P-50	50	.35 lbs
	#10 x .75" Phillips Head Screws <i>Steel flat head screws for setting angle on Montage Plus swivel brackets</i>	1-0005-1P	1-0005-2P	1	.005 lbs
	.25" x 1.75" Carriage Bolts <i>Steel carriage bolt for Montage Plus brackets</i>	2-0007-1P	2-0007-2P	1	.027 lbs
	.25" Tee Nuts	B7157RP-20	N7157RP-20	20	.3 lbs
	Fastener Socket	8865PFG	n/a	1	.06 lbs
	One-Way Screw Remover	88246P	1	.10 lbs	n/a

⊗ = COLOR OPTIONS AVAILABLE | B = Black N = Bronze

MONTAGE® | CUSTOM FINISHES

WARRANTY ON CUT COMPONENTS VOID WITHOUT PROPER TOUCH-UP APPLICATION*

*For details & the guidelines for the proper 3-step process, see Ameristar's Sales Policy in the catalog guide

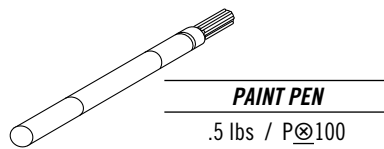

⊗ = COLOR OPTIONS AVAILABLE | B = Black N = Bronze

Effective: 01/06/15

MONTAGE PLUS® | STEEL SQUARE POSTS

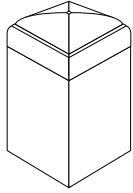

STEEL POSTS

	POST LENGTH	ITEM NUMBER	WEIGHT
2.5"sq. x 16ga.	6'	WP⊗25072	12 lbs
	7'	WP⊗25084	14 lbs
	8'	WP⊗25096	16 lbs
	9'	WP⊗25108	18 lbs
2.5"sq. x 14ga.	8'	WP⊗25096-14	20 lbs
	9'	WP⊗25108-14	23 lbs
	10'	WP⊗25120-14	25 lbs
	11'	WP⊗25132-14	27 lbs
3"sq. x 12ga.	5'	P⊗30060	20 lbs
	6'	P⊗30072	24 lbs
	7'	P⊗30084	30 lbs
	8'	P⊗30096	34 lbs
	9'	P⊗30108	39 lbs
	10'	P⊗30120	43 lbs
4"sq. x 11ga.	6'	P⊗40072	39 lbs
	7'	P⊗40084	47 lbs
	8'	P⊗40096	54 lbs
	9'	P⊗40108	61 lbs
	10'	P⊗40120	67 lbs
6"sq. x .1875" wall	7'	P⊗60084	102 lbs
	8'	P⊗60096	116 lbs
	9'	P⊗60108	131 lbs
	10'	P⊗60120	145 lbs
8"sq. x .25" wall	9'	P⊗80108	233 lbs
	10'	P⊗80120	259 lbs

⊗ = COLOR OPTIONS AVAILABLE | **B** = Black **N** = Bronze

NOTE: In locations subject to freezing temperatures, where posts are grouted into core-drilled holes, a .25" diameter hole should be drilled into the post approximately .5" above the elevation to allow for drainage of ground water build-up. The drilled hole must be wiped clean and be dry prior to applying Ameristar zinc primer and color finish.

Effective: 01/06/15

MONTAGE PLUS® | STEEL PLATED SQUARE POSTS

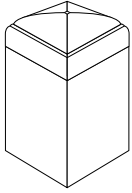

STEEL POSTS

	POST LENGTH	PLATE SIZE	ITEM NUMBER	WEIGHT
2.5"sq. x 12ga.	4'	5" sq. x .25" / .5625 holes (8833G)	P⊗ 25048P	16 lbs
	5'	5" sq. x .25" / .5625 holes (8833G)	P⊗ 25060P	19 lbs
	6'	5" sq. x .25" / .5625 holes (8833G)	P⊗ 25072P	22 lbs
3"sq. x 12ga.	4'	6" sq. x .25" / .5625 holes (5003G)	P⊗ 30048P	20 lbs
	5'	6" sq. x .25" / .5625 holes (5003G)	P⊗ 30060P	24 lbs
	6'	6" sq. x .25" / .5625 holes (5003G)	P⊗ 30072P	30 lbs
4"sq. x 11ga.	4'	8" sq. x .375" / .5625 holes (8876G)	P⊗ 40048P	33 lbs
	5'	8" sq. x .375" / .5625 holes (8876G)	P⊗ 40060P	39 lbs
	6'	8" sq. x .375" / .5625 holes (8876G)	P⊗ 40072P	47 lbs

⊗ = COLOR OPTIONS AVAILABLE | **B** = Black **N** = Bronze

NOTE: Posts used with Majestic may require an additional 1" longer than the panel or gate height, depending on the grade elevation.

MONTAGE PLUS® | POST CAPS

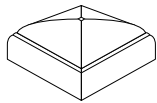

STANDARD FLAT CAP
Steel

CAP SIZE	ITEM NUMBER	WEIGHT
1.75" sq	A⊗ 505P	.1 lbs
2" sq	A⊗ 506	.2 lbs
2.5" sq	A⊗ 507	.3 lbs
3" sq	A⊗ 508	.3 lbs
4" sq	A⊗ 509	.4 lbs
6" sq	A⊗ 515	.8 lbs
8" sq	A⊗ 801	2 lbs



BALL CAP
Aluminum

CAP SIZE	ITEM NUMBER	WEIGHT
2" sq	H⊗ 508R	.7 lbs
2.5" sq	A⊗ 513	.7 lbs
3" sq	A⊗ 516	.8 lbs
4" sq	A⊗ 517	2 lbs
6" sq	A⊗ 521	8 lbs

⊗ = COLOR OPTIONS AVAILABLE | **B** = Black **N** = Bronze **W** = White
S = Sand

Effective: 01/06/15

MONTAGE PLUS® | CONSTRUCTION SPECIFICATION 32 31 19

STEEL ORNAMENTAL FENCE SYSTEM – FUSION WELDED & RACKABLE

PART 1 - GENERAL

1.01 WORK INCLUDED

The contractor shall provide all labor, materials and appurtenances necessary for installation of the welded ornamental steel fence system defined herein at (*specify project site*).

1.02 RELATED WORK

Section _____ - Earthwork

Section _____ - Concrete

1.03 SYSTEM DESCRIPTION

The manufacturer shall supply a total fence system of (*specify Montage Plus® standard picket space or Montage Plus Pool, Pet & Play® 3" air space*) Welded and Rackable (ATF – All Terrain Flexibility) Ornamental Steel (*for standard picket space, specify Classic™, Majestic™, Genesis™, or Warrior™; for 3" air space, specify Classic, Majestic, or Genesis*) design. The system shall include all components (*i.e., panels, posts, gates and hardware*) required.

1.04 QUALITY ASSURANCE

The contractor shall provide laborers and supervisors who are thoroughly familiar with the type of construction involved and materials and techniques specified.

1.05 REFERENCES

- **ASTM A653/A653M** – Standard Specification for Steel Sheet, Zinc-Coated (*Galvanized*) or Zinc-Iron Alloy Coated (*Galvanized*) by the Hot-Dip Process
- **ASTM B117** – Practice for Operating Salt-Spray (*Fog*) Apparatus
- **ASTM D523** – Test Method for Specular Gloss
- **ASTM D714** – Test Method for Evaluating Degree of Blistering in Paint
- **ASTM D822** – Practice for Conducting Tests on Paint and Related Coatings and Materials using Filtered Open-Flame Carbon-Arc Light and Water Exposure Apparatus
- **ASTM D1654** – Test Method for Evaluation of Painted or Coated Specimens Subjected to Corrosive Environments
- **ASTM D2244** – Test Method for Calculation of Color Differences from Instrumentally Measured Color Coordinates
- **ASTM D2794** – Test Method for Resistance of Organic Coatings to the Effects of Rapid Deformation (*Impact*)
- **ASTM D3359** – Test Method for Measuring Adhesion by Tape Test
- **ASTM F2408** – Ornamental Fences Employing Galvanized Steel Tubular Pickets

1.06 SUBMITTAL

The manufacturer's literature shall be submitted prior to installation.

1.07 PRODUCT HANDLING AND STORAGE

Upon receipt at the job site, all materials shall be checked to ensure that no damage occurred during shipping or handling. Materials shall be stored in such a manner to ensure proper ventilation and drainage, and to protect against damage, weather, vandalism and theft.

1.08 PRODUCT WARRANTY

- A. All structural fence components (*i.e. rails, pickets, and posts*) shall be warranted within specified limitations, by the manufacturer for a period of 20 years from date of original purchase. Warranty shall cover any defects in material finish, including cracking, peeling, chipping, blistering or corroding.
- B. Reimbursement for labor necessary to restore or replace components that have been found to be defective under the terms of manufacturer's warranty shall be guaranteed for five (5) years from date of original purchase.

PART 2 - MATERIALS

2.01 MANUFACTURER

The fence system shall conform to (*specify Montage Plus standard picket space or Montage Plus Pool, Pet & Play 3" air space*) Welded and Rackable (ATF – All Terrain Flexibility) Ornamental Steel, (*for standard picket space, specify Classic, Majestic, Genesis or Warrior; for 3" air space, specify Classic, Majestic, or Genesis*) design, (*specify extended picket or flush*) bottom rail treatment, (*specify 2-Rail, 3-Rail or 3-Rail with Double Rings*) style manufactured by Ameristar Fence Products, Inc., in Tulsa, Oklahoma.

2.02 MATERIAL

- A. Steel material for fence panels and posts shall conform to the requirements of **ASTM A653/A653M**, with a minimum yield strength of 45,000 psi (310 MPa) and a minimum zinc (*hot-dip galvanized*) coating weight of 0.60 oz/ft² (184 g/m²), Coating Designation G-60.
- B. Material for pickets shall be .75" square x 18 Ga. tubing. The rails shall be steel channel, 1.5" x 1.4375" x 14 Ga. Picket holes in the rail shall be spaced (*specify 4.675" o.c. for standard picket space or 3.500" o.c. for 3" air space*). Fence posts and gate posts shall meet the minimum size requirements of **Table 1**.

2.03 FABRICATION

- A. Pickets, rails and posts shall be pre-cut to specified lengths. Rails shall be pre-punched to accept pickets.
- B. Pickets shall be inserted into the pre-punched holes in the rails and shall be aligned to standard spacing using a specially calibrated alignment fixture. The aligned pickets and rails shall be joined at each picket-to-rail intersection

Effective: 01/06/15

MONTAGE PLUS® | CONSTRUCTION SPECIFICATION 32 31 19

STEEL ORNAMENTAL FENCE SYSTEM – FUSION WELDED & RACKABLE

by Ameristar's proprietary fusion welding process, thus completing the rigid panel assembly (*Note: The process produces a virtually seamless, spatter-free good-neighbor appearance, equally attractive from either side of the panel*).

- C. The manufactured panels and posts shall be subjected to an in-line electrode position coating (E-Coat) process consisting of a multi-stage pretreatment/wash (with zinc phosphate), followed by a duplex application of an epoxy primer and an acrylic topcoat. The minimum cumulative coating thickness of epoxy and acrylic shall be 2 mils (0.058 mm). The color shall be (*specify Black or Bronze*). The coated panels and posts shall be capable of meeting the performance requirements for each quality characteristic shown in **Table 2** (*Note: The requirements in Table 2 meet or exceed the coating performance criteria of ASTM F2408*).
- D. The manufactured fence system shall be capable of meeting the vertical load, horizontal load, and infill performance requirements for Industrial weight fences under **ASTM F2408**.
- E. Gates with an out to out leaf dimension less than and including 72 inches shall be fabricated using Montage Plus ornamental panel material and 1.75" sq. x 14ga. gate ends. Gate leaves greater than 72" shall be fabricated using ForeRunner rails, 17 gauge pickets, intermediate uprights, gussets and 1.75" sq. x 14ga. gate ends. All rail and upright intersections shall be joined by welding. All picket and rail intersections shall also be joined by welding.

PART 3 - EXECUTION

3.01 PREPARATION

All new installation shall be laid out by the contractor in accordance with the construction plans.

3.02 INSTALLATION

Fence post shall be spaced according to **Table 3**, plus or minus .25". For installations that must be raked to follow sloping grades, the post spacing dimension must be measured along the grade. Fence panels shall be attached to posts with brackets supplied by the manufacturer. Posts shall be set in concrete footers having a minimum depth of 36" (*Note: In some cases, local restrictions of freezing weather conditions may require a greater depth*). The "Earthwork" and "Concrete" sections of this specification shall govern material requirements for the concrete footer. Posts setting by other methods such as plated posts or grouted core-drilled footers are permissible only if shown by engineering analysis to be sufficient in strength for the intended application.

3.03 FENCE INSTALLATION MAINTENANCE

When cutting/drilling rails or posts adhere to the following steps to seal the exposed steel surfaces; 1) Remove all metal shavings from cut area. 2) Apply zinc-rich primer to thoroughly cover cut edge and/or drilled hole; let dry. 3) Apply 2 coats of custom finish paint matching fence color. Failure to seal exposed surfaces per steps 1-3 above will negate warranty. Ameristar spray cans or paint pens shall be used to prime and finish exposed surfaces; it is recommended that paint pens be used to prevent overspray. Use of non-Ameristar parts or components will negate the manufacturer's warranty.

3.04 GATE INSTALLATION

Gate posts shall be spaced according to the manufacturer's gate drawings, dependent on standard out-to-out gate leaf dimensions and gate hardware selected. Type and quantity of gate hinges shall be based on the application; weight, height, and number of gate cycles. The manufacturer's gate drawings shall identify the necessary gate hardware required for the application. Gate hardware shall be provided by the manufacturer of the gate and shall be installed per manufacturer's recommendations.

3.05 CLEANING

The contractor shall clean the jobsite of excess materials; post-hole excavations shall be scattered uniformly away from posts.

SEE REFERENCED TABLES ON THE FOLLOWING PAGE

Effective: 01/06/15

MONTAGE PLUS® | CONSTRUCTION SPECIFICATION 32 31 19

WELDED ORNAMENTAL STEEL FENCE PRODUCTS

TABLE 1

MINIMUM SIZES FOR MONTAGE PLUS POSTS		
FENCE POSTS	PANEL HEIGHTS	
2.5" x 16 ga.	up to & including 6' heights	
GATE LEAF	GATE HEIGHT	
	up to & including 4'	over 4' up to & including 6'
up to 4'	2.5" x 16 gauge	2.5" x 14 gauge
4'1" to 6'	3" x 12 gauge	3" x 12 gauge
6'1" to 10'	4" x 11 gauge	4" x 11 gauge
10'1" to 16'	6" x 3/16" wall	6" x 3/16" wall

TABLE 2

COATING PERFORMANCE REQUIREMENTS		
QUALITY CHARACTERISTICS	ASTM TEST METHOD	PERFORMANCE REQUIREMENTS
ADHESION	D3359 – METHOD B	Adhesion (<i>retention of coating</i>) over 90% of test area (<i>tape and knife kit test</i>).
CORROSION RESISTANCE	B117, D714, D1654	Corrosion resistance over 1,500 hours (<i>scribed per D1654; failure mode is accumulation of 1/8" coating loss from scribe or medium #8 blisters</i>)
IMPACT RESISTANCE	D2794	Impact resistance over 60" lb. (<i>forward impact using 0.625" ball</i>).
WEATHERING RESISTANCE	D822 D2244, D523 (60° method)	Weathering resistance over 1,000 hours (<i>failure mode is 60% loss of gloss or color variance of more than 3 delta-E color units</i>).

TABLE 3

MONTAGE PLUS POST SPACING BY BRACKET TYPE						
SPAN	Classic, Genesis, Majestic & Warrior / 8' nominal (91.95" rail)					
POST SIZE	2.5"	2.5"	2.5"	3"	2.5"	3"
BRACKET TYPE	Montage Plus Universal (BB112)	Montage Plus Line Blvd. (BB114)	Montage Plus Flat Mount (BB111)		Montage Plus Swivel (BB113)*	
POST SETTINGS ± .25" O.C.	95"	95"	95"	95.5"	*95"	*95.5"

*When using BB113 swivel brackets on either or both ends of a panel installation, care must be taken to ensure the spacing between post and adjoining pickets meets applicable codes. This will require trimming one or both ends of the panel.

TABLE 4

MONTAGE PLUS WIND LOADING						
FENCE HEIGHT	RAIL LENGTH	POST SIZE	PICKETS WITH 3.925" AIRSPACE		TYPICAL WIND LOAD CAPACITY (MPH)	
			WIND LOAD CAPACITY FACTOR (PSF)	TYPICAL WIND LOAD CAPACITY (MPH)	WIND LOAD CAPACITY FACTOR (PSF)	TYPICAL WIND LOAD CAPACITY (MPH)
4'	8'	2.5" x 2.5" x 16 ga.	66 (PSF)	179 (MPH)	57 (PSF)	166 (MPH)
5'	8'	2.5" x 2.5" x 16 ga.	45.5 (PSF)	149 (MPH)	39 (PSF)	137 (MPH)
6'	8'	2.5" x 2.5" x 16 ga.	32 (PSF)	125 (MPH)	28 (PSF)	116 (MPH)
7'	8'	2.5" x 2.5" x 14 ga.	30 (PSF)	121 (MPH)	25 (PSF)	110 (MPH)
8'	8'	2.5" x 2.5" x 14 ga.	24 (PSF)	107 (MPH)	20 (PSF)	98 (MPH)

MPH values shown in Table 4 are provided for information only. They are calculated using ANSI/ASCE 7-05, "American Society of Civil Engineers Minimum Design Loads for Buildings and Other Structures" Exposure Category C (open terrain with scattered obstructions having lengths generally less than 30 feet), based on post setting in 36" deep concrete footer in soil assumed to be of mid-range strength and compaction. Since specified project conditions such as jurisdictional building codes, elevation of installation, post base/footer design, soil strength, etc., may change from project to project, a structural engineering evaluation, unique to applicable requirements and conditions, should be performed. Consult your Ameristar Service Representative for an estimate on Engineering Analysis and P.E. Certification

Effective: 01/06/15

MONTAGE PLUS® | LIMITED WARRANTY

WELDED ORNAMENTAL FENCE

Ameristar's Montage Plus® welded ornamental fences are manufactured from the highest quality materials by skilled craftsmen to meet the highest standards of workmanship in the industry. Galvanized steel framework is subjected to a multi-stage pretreatment/wash (with zinc phosphate), followed by a duplex cathodic electro-coat system consisting of an epoxy primer, which significantly increases corrosion protection, and an acrylic liquid topcoat, which provides the protection necessary to withstand adverse weathering effects. The electro-coated surface on all Montage Plus welded ornamental panels and posts are guaranteed under normal and intended usage, against cracking, peeling, chipping, blistering or corroding commencing with the original purchase date and extending according to the applications defined in the table below. Normal and intended usage does not include physical damage, abrasion, or heavy salt spray exposure to the protective coating.

THE FOLLOWING ACTS AND/OR OMISSIONS WILL VOID THE SUBJECT WARRANTY:

- Damage to the product caused by the property owner by use of landscape, gardening equipment, chemicals that may cause damage, and/or water sprinklers with high mineral content;
- Damage caused by adhesion of chicken wire, chain link mesh, welded wire, or other similar substance to the product;
- Damage caused by allowing plant life of any sort to grow directly upon or in contact with any portion of the product or sap from trees;
- Any alteration to the product itself by the property owner including any on-site cutting or welding; and/or, failure to follow any and all maintenance instructions provided by Ameristar® at the time of sale to the original purchaser even if these instructions are not forwarded to the ultimate claimant under this warranty.
- When cutting Montage Plus immediately seal the exposed surfaces by 1) Removing all metal shavings from the cut area 2) Apply ing zinc-rich primer to thoroughly cover cut edge and drilled hole and, after letting dry, 3) Applying two (2) coats of custom finish spray paint matching fence color. Failure to seal exposed surfaces per steps 1-3 above will negate warranty.
- If contractor uses non-Ameristar parts/components, this will negate the warranty.

Ameristar Montage Plus welded ornamental fences are also guaranteed for the same period of time against defects in workmanship or materials. Should any Montage Plus welded ornamental panel or post manufactured by Ameristar fail in accordance with any of the above conditions, Ameristar warrants to the original purchaser their redemption through replacement, renewal or issuance of a pro-rated credit. The choice of redemption method is solely at the

APPLICATION	LENGTH OF WARRANTY
Fence Installations 0 to 1 Mile from Salt Water Coast Line	5 YEARS
Fence Installations 1 Mile to 10 Miles from Salt Water Coast Line	10 YEARS
Fence Installations Over 10 Miles from Salt Water Coast Line	20 YEARS

Regardless of location and years in service, evidence of historical salt spray exposure shall be considered as grounds to void any warranty obligations.

discretion of Ameristar. If the pro-rated alternative is chosen, the amount will be based on the original cost of materials at the date of purchase multiplied by the appropriate time and exposure factor from the table below:

Notice of failure under the conditions of this warranty shall be sent to Ameristar or its authorized representative, in writing, together with proof of purchase and shall specify the nature of the defect and when it was first observed as well as photographs of current site conditions. Should the fence be improperly installed, Ameristar shall not be responsible for guaranteed performance or appearance of the material. Neither does this guarantee apply when failure or damage is due to improper use or application, abuse or misuse, salt spray exposure (see Table and Note above), vandalism, or acts of God. Ameristar reserves the right to inspect the material to determine validity of the claim.

Upon acceptance of the claim by Ameristar or its authorized representative, redemption by replacement, renewal or issuance of a pro-rated credit shall be made by Ameristar. Reimbursement for labor necessary to restore and/or replace components that have been found defective under the terms of this warranty is guaranteed to the original purchaser for a period of five (5) years from the original purchase date. Ameristar reserves the right to select the qualified company or individual to perform the labor to repair or replace the components that are deemed to be defective under the terms of this warranty.

The above constitutes the complete warranty by the manufacturer. No other agreement, written or implied, is valid. Ameristar Fence Products does not authorize any other person or agent to make any other express warranties. Ameristar neither assumes nor authorizes any other person or agent to assume any other liability in connection with the Montage Plus welded ornamental fence system.

Effective: 01/06/15

MONTAGE PLUS® | SINGLE SWING GATE SPECIFICATIONS

1.75"sq x 14ga STEEL GATE ENDS | 1.4375" x 1.5" x 14ga RAILS | .75"sq x 18ga PICKETS | 3.5' - 16' NOMINAL OPENINGS

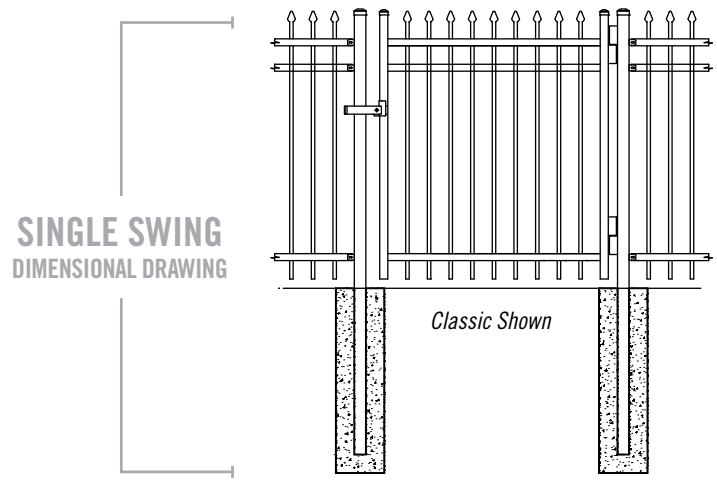

IGBSX25 / IGBSX3 BOX HINGE KITS | HGBS-25 HGBS-3 / HGBS-4 HEAVY COMMERCIAL HINGE KITS | IGBS-25 IGBS-3 / IGBS-4 INDUSTRIAL HINGE KITS

SINGLE SWING
 HARDWARE KITS & POST
 INTERSPACES

OPENING	LEAF WIDTH*	HC	LC	P _s	HC	LC	P _s	HC	LC	P _s
3.5'	40"	2"	2"	44"	1.25"	3"	44.25"	1.5"	3"	44.5"
4'	49.5"	2"	2"	53.5"	1.25"	3"	53.75"	1.5"	3"	54"
5'	58.75"	2"	2"	62.75"	1.25"	3"	63"	1.5"	3"	63.25"
6'	68"	2"	2"	72"	1.25"	3"	72.25"	1.5"	3"	72.5"
7'	86.75"	2"	2"	90.75"	1.25"	3"	91"	1.5"	3"	91.25"
8'	95.5"	2"	2"	99.5"	1.25"	3"	99.75"	1.5"	3"	100"
9'	105.5"	2"	2"	109.5"	1.25"	3"	109.75"	1.5"	3"	110"
10'	114.75"	2"	2"	118.75"	1.25"	3"	119"	1.5"	3"	119.25"
11'	133.5"	2"	2"	137.5"	1.25"	3"	137.75"	1.5"	3"	138"
12'	143"	2"	2"	147"	1.25"	3"	147.25"	1.5"	3"	147.5"
13'	152.25"	2"	2"	156.25"	1.25"	3"	156.5"	1.5"	3"	156.75"
14'	171"	2"	2"	175"	1.25"	3"	175.25"	1.5"	3"	175.5"
15'	180.25"	2"	2"	184.25"	1.25"	3"	184.5"	1.5"	3"	184.75"
16'	189.75"	2"	2"	193.75"	1.25"	3"	194"	1.5"	3"	194.25"

W = width* | HC = hinge clearance | LC = latch clearance | P_s = gate post spacing**
 * From outside to outside | ** From inside to inside

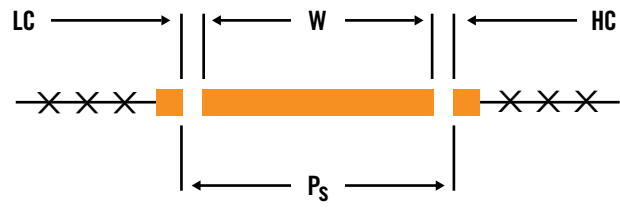

Effective: 01/06/15

MONTAGE PLUS® | DOUBLE SWING GATE SPECIFICATIONS

1.75"sq x 14ga STEEL GATE ENDS | 1.4375" x 1.5" x 14ga RAILS | .75"sq x 18ga PICKETS | 7' - 32' NOMINAL OPENINGS

DOUBLE SWING
DIMENSIONAL DRAWING

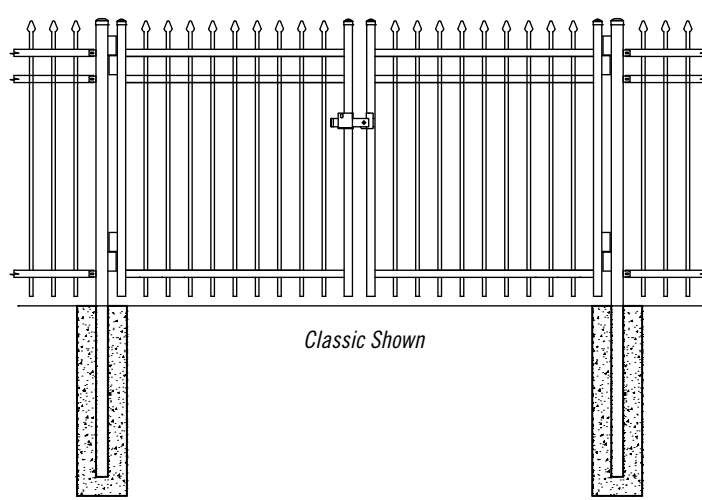

DOUBLE SWING
HARDWARE KITS & POST
INTERSPACES



OPENING	LEAF WIDTH*	IGBDX BOX HINGE KITS			IGBD INDUSTRIAL HINGE KITS		
		HC	LC	P _d	HC	LC	P _d
7'	40"	2"	2"	86"	1.25"	3"	85.5"
8'	49.5"	2"	2"	105"	1.25"	3"	104.5"
10'	58.75"	2"	2"	123.5"	1.25"	3"	123"
12'	68"	2"	2"	142"	1.25"	3"	141.5"
14'	86.75"	2"	2"	179.5"	1.25"	3"	179"
16'	95.5"	2"	2"	197"	1.25"	3"	196.5"
18'	105.5"	2"	2"	217"	1.25"	3"	216.5"
20'	114.75"	2"	2"	235.5"	1.25"	3"	235"
22'	133.5"	2"	2"	273"	1.25"	3"	272.5"
24'	143"	2"	2"	292"	1.25"	3"	291.5"
26'	152.25"	2"	2"	310.5"	1.25"	3"	310"
28'	171"	2"	2"	348"	1.25"	3"	347.5"
30'	180.25"	2"	2"	366.5"	1.25"	3"	366"
32'	189.75"	2"	2"	385.5"	1.25"	3"	385"

W = width (x2)* | HC = hinge clearance (x2) | LC = latch clearance

P_d = gate post spacing**

* From outside to outside | ** From inside to inside

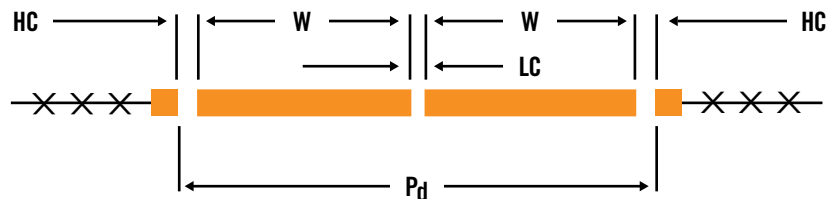

Effective: 01/06/15

TO PLACE YOUR ORDER CALL 888-333-3422 | VISIT AMERISTARFENCE.COM

AMERISTAR®
ASSA ABLOY

MONTAGE PLUS® | 2-RAIL SINGLE SWING GATES

4" AIR GAP | STANDARD BOTTOM | GATE HARDWARE SOLD SEPARATELY

	OPENING	LEAF WIDTH	ITEM NUMBER	PICKET QTY	WEIGHT	STOCKING
3' HEIGHT	3.5'	40"	1W☒⊗234-42	7	27 lbs	☉
	4'	49.5"	1W☒⊗234-48	9	32 lbs	☉
	5'	58.75"	1W☒⊗234-60	11	36 lbs	☉
	6'	68"	1W☒⊗234-72	13	41 lbs	☉
	7'	86.75"	1W☒⊗234-84	17	49 lbs	☉
	8'	95.5"	1W☒⊗234-96	19	53 lbs	☉
	9'	105.5"	1W☒⊗234-108	21	93 lbs	☉
	10'	114.75"	1W☒⊗234-120	23	102 lbs	☉
	11'	133.5"	1W☒⊗234-132	27	115 lbs	☉
	12'	143"	1W☒⊗234-144	29	129 lbs	☉
	13'	152.25"	1W☒⊗234-156	31	140 lbs	☉
	14'	171"	1W☒⊗234-168	35	148 lbs	☉
3.5' HEIGHT	15'	180.25"	1W☒⊗234-180	37	156 lbs	☉
	16'	189.75"	1W☒⊗234-192	39	167 lbs	☉
	3.5'	40"	1W☒⊗240-42	7	30 lbs	☉
	4'	49.5"	1W☒⊗240-48	9	36 lbs	☉
	5'	58.75"	1W☒⊗240-60	11	41 lbs	☉
	6'	68"	1W☒⊗240-72	13	46 lbs	☉
	7'	86.75"	1W☒⊗240-84	17	54 lbs	☉
	8'	95.5"	1W☒⊗240-96	19	73 lbs	☉
	9'	105.5"	1W☒⊗240-108	21	104 lbs	☉
	10'	114.75"	1W☒⊗240-120	23	113 lbs	☉
	11'	133.5"	1W☒⊗240-132	27	127 lbs	☉
	4' HEIGHT	12'	143"	1W☒⊗240-144	29	142 lbs
13'		152.25"	1W☒⊗240-156	31	153 lbs	☉
14'		171"	1W☒⊗240-168	35	162 lbs	☉
15'		180.25"	1W☒⊗240-180	37	171 lbs	☉
16'		189.75"	1W☒⊗240-192	39	182 lbs	☉
3.5'		40"	1W☒⊗246-42	7	37 lbs	☉
4'		49.5"	1W☒⊗246-48	9	40 lbs	☉
5'		58.75"	1W☒⊗246-60	11	49 lbs	☉
6'		68"	1W☒⊗246-72	13	57 lbs	☉
7'		86.75"	1W☒⊗246-84	17	63 lbs	☉
8'	95.5"	1W☒⊗246-96	19	73 lbs	☉	
9'	105.5"	1W☒⊗246-108	21	110 lbs	☉	
10'	114.75"	1W☒⊗246-120	23	121 lbs	☉	

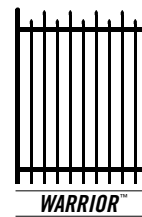
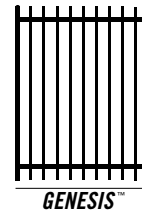
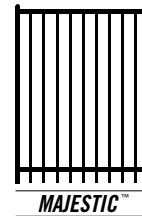
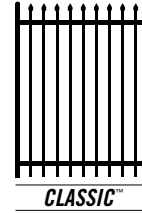

ADDITIONAL 4', 5' & 6' HEIGHTS CONTINUED ON NEXT PAGE

Effective: 01/06/15

MONTAGE PLUS® | 2-RAIL SINGLE SWING GATES

4" AIR GAP | STANDARD BOTTOM | GATE HARDWARE SOLD SEPARATELY

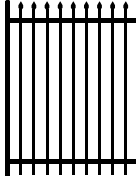
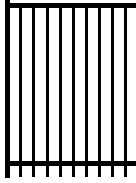
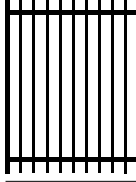
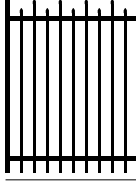
	OPENING	LEAF WIDTH	ITEM NUMBER	PICKET QTY	WEIGHT	STOCKING		
4' HEIGHT	11'	133.5"	1W☒Ⓞ246-132	27	138 lbs	☉	 CLASSIC™	
	12'	143"	1W☒Ⓞ246-144	29	155 lbs	☉		
	13'	152.25"	1W☒Ⓞ246-156	31	166 lbs	☉		
	14'	171"	1W☒Ⓞ246-168	35	176 lbs	☉		
	15'	180.25"	1W☒Ⓞ246-180	37	186 lbs	☉		
	16'	189.75"	1W☒Ⓞ246-192	39	197 lbs	☉		
5' HEIGHT	3.5'	40"	1W☒Ⓞ258-42	7	46 lbs	☉	 MAJESTIC™	
	4'	49.5"	1W☒Ⓞ258-48	9	49 lbs	☉		
	5'	58.75"	1W☒Ⓞ258-60	11	59 lbs	☉		
	6'	68"	1W☒Ⓞ258-72	13	69 lbs	☉		
	7'	86.75"	1W☒Ⓞ258-84	17	75 lbs	☉		
	8'	95.5"	1W☒Ⓞ258-96	19	88 lbs	☉		
	9'	105.5"	1W☒Ⓞ258-108	21	127 lbs	☉		
	10'	114.75"	1W☒Ⓞ258-120	23	140 lbs	☉		
	11'	133.5"	1W☒Ⓞ258-132	27	161 lbs	☉		
	12'	143"	1W☒Ⓞ258-144	29	181 lbs	☉		
6' HEIGHT	13'	152.25"	1W☒Ⓞ258-156	31	192 lbs	☉	 GENESIS™	
	14'	171"	1W☒Ⓞ258-168	35	204 lbs	☉		
	15'	180.25"	1W☒Ⓞ258-180	37	216 lbs	☉		
	16'	189.75"	1W☒Ⓞ258-192	39	227 lbs	☉		
	3.5'	40"	1W☒Ⓞ270-42	7	54 lbs	☉		 WARRIOR™
	4'	49.5"	1W☒Ⓞ270-48	9	58 lbs	☉		
	5'	58.75"	1W☒Ⓞ270-60	11	69 lbs	☉		
	6'	68"	1W☒Ⓞ270-72	13	80 lbs	☉		
	7'	86.75"	1W☒Ⓞ270-84	17	88 lbs	☉		
	8'	95.5"	1W☒Ⓞ270-96	19	104 lbs	☉		
9'	105.5"	1W☒Ⓞ270-108	21	144 lbs	☉			
10'	114.75"	1W☒Ⓞ270-120	23	159 lbs	☉			
11'	133.5"	1W☒Ⓞ270-132	27	183 lbs	☉			
12'	143"	1W☒Ⓞ270-144	29	206 lbs	☉			
13'	152.25"	1W☒Ⓞ270-156	31	220 lbs	☉			
14'	171"	1W☒Ⓞ270-168	35	233 lbs	☉			
15'	180.25"	1W☒Ⓞ270-180	37	246 lbs	☉			
16'	189.75"	1W☒Ⓞ270-192	39	258 lbs	☉			

☒ = FENCE STYLES AVAILABLE | C = Classic M = Majestic G = Genesis W = Warrior

Ⓞ = COLOR OPTIONS AVAILABLE | B = Black N = Bronze

☉ = NON-STOCKED PRODUCT

For details, see Ameristar's Sales Policy in the catalog guide.

Effective: 01/06/15

MONTAGE PLUS® | 2-RAIL SINGLE SWING GATES

3" AIR GAP | STANDARD BOTTOM | GATE HARDWARE SOLD SEPARATELY

	OPENING	LEAF WIDTH	ITEM NUMBER	PICKET QTY	WEIGHT	STOCKING
3' HEIGHT	3.5'	40"	1R☒Ⓞ234-42	9	30 lbs	☉
	4'	49.5"	1R☒Ⓞ234-48	12	34 lbs	☉
	5'	58.75"	1R☒Ⓞ234-60	14	40 lbs	☉
	6'	68"	1R☒Ⓞ234-72	17	46 lbs	☉
	7'	86.75"	1R☒Ⓞ234-84	22	54 lbs	☉
	8'	95.5"	1R☒Ⓞ234-96	24	60 lbs	☉
3.5' HEIGHT	3.5'	40"	1R☒Ⓞ240-42	9	34 lbs	☉
	4'	49.5"	1R☒Ⓞ240-48	12	39 lbs	☉
	5'	58.75"	1R☒Ⓞ240-60	14	46 lbs	☉
	6'	68"	1R☒Ⓞ240-72	17	52 lbs	☉
	7'	86.75"	1R☒Ⓞ240-84	22	61 lbs	☉
	8'	95.5"	1R☒Ⓞ240-96	24	68 lbs	☉
4' HEIGHT	3.5'	40"	1R☒Ⓞ246-42	9	39 lbs	☉
	4'	49.5"	1R☒Ⓞ246-48	12	42 lbs	☉
	5'	58.75"	1R☒Ⓞ246-60	14	53 lbs	☉
	6'	68"	1R☒Ⓞ246-72	17	61 lbs	☉
	7'	86.75"	1R☒Ⓞ246-84	22	69 lbs	☉
	8'	95.5"	1R☒Ⓞ246-96	24	80 lbs	☉

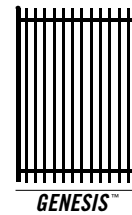
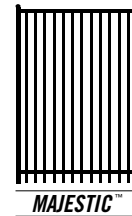
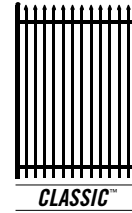

☒ = FENCE STYLES AVAILABLE | C = Classic M = Majestic G = Genesis

Ⓞ = COLOR OPTIONS AVAILABLE | B = Black N = Bronze

☉ = NON-STOCKED PRODUCT

For details, see Ameristar's Sales Policy in the catalog guide.

Notes: Genesis panels are packaged with BLACK picket plugs for black & bronze.

Effective: 01/06/15

MONTAGE PLUS® | 2-RAIL SINGLE SWING GATES

3" AIR GAP | STANDARD BOTTOM | GATE HARDWARE SOLD SEPARATELY

	OPENING	LEAF WIDTH	ITEM NUMBER	PICKET QTY	WEIGHT	STOCKING
5' HEIGHT	3.5'	40"	1R☒Ⓞ258-42	9	48 lbs	Ⓞ
	4'	49.5"	1R☒Ⓞ258-48	12	51 lbs	Ⓞ
	5'	58.75"	1R☒Ⓞ258-60	14	64 lbs	Ⓞ
	6'	68"	1R☒Ⓞ258-72	17	74 lbs	Ⓞ
	7'	86.75"	1R☒Ⓞ258-84	22	83 lbs	Ⓞ
6' HEIGHT	8'	95.5"	1R☒Ⓞ258-96	24	97 lbs	Ⓞ
	3.5'	40"	1R☒Ⓞ270-42	9	56 lbs	Ⓞ
	4'	49.5"	1R☒Ⓞ270-48	12	60 lbs	Ⓞ
	5'	58.75"	1R☒Ⓞ270-60	14	75 lbs	Ⓞ
	6'	68"	1R☒Ⓞ270-72	17	87 lbs	Ⓞ
	7'	86.75"	1R☒Ⓞ270-84	22	97 lbs	Ⓞ
	8'	95.5"	1R☒Ⓞ270-96	24	113 lbs	Ⓞ

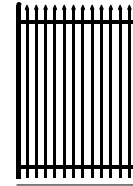

CLASSIC™

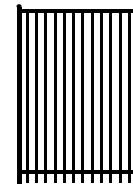

MAJESTIC™

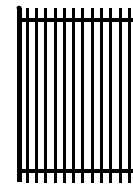

GENESIS™

☒ = FENCE STYLES AVAILABLE | **C** = Classic **M** = Majestic **G** = Genesis

Ⓞ = COLOR OPTIONS AVAILABLE | **B** = Black **N** = Bronze

Ⓞ = NON-STOCKED PRODUCT

For details, see Ameristar's Sales Policy in the catalog guide.

Notes: Genesis panels are packaged with BLACK picket plugs for black & bronze.

Effective: 01/06/15

MONTAGE PLUS® | 2-RAIL SINGLE SWING GATES

4" AIR GAP | FLUSH BOTTOM | GATE HARDWARE SOLD SEPARATELY

	OPENING	LEAF WIDTH	ITEM NUMBER	PICKET QTY	WEIGHT	STOCKING
3' HEIGHT	3.5'	40"	1W☒⊗234F-42	7	27 lbs	☉
	4'	49.5"	1W☒⊗234F-48	9	32 lbs	☉
	5'	58.75"	1W☒⊗234F-60	11	36 lbs	☉
	6'	68"	1W☒⊗234F-72	13	41 lbs	☉
	7'	86.75"	1W☒⊗234F-84	17	49 lbs	☉
	8'	95.5"	1W☒⊗234F-96	19	53 lbs	☉
	9'	105.5"	1W☒⊗234F-108	21	93 lbs	☉
	10'	114.75"	1W☒⊗234F-120	23	102 lbs	☉
	11'	133.5"	1W☒⊗234F-132	27	115 lbs	☉
	12'	143"	1W☒⊗234F-144	29	129 lbs	☉
	13'	152.25"	1W☒⊗234F-156	31	140 lbs	☉
	14'	171"	1W☒⊗234F-168	35	148 lbs	☉
3.5' HEIGHT	15'	180.25"	1W☒⊗234F-180	37	156 lbs	☉
	16'	189.75"	1W☒⊗234F-192	39	167 lbs	☉
	3.5'	40"	1W☒⊗240F-42	7	30 lbs	☉
	4'	49.5"	1W☒⊗240F-48	9	36 lbs	☉
	5'	58.75"	1W☒⊗240F-60	11	41 lbs	☉
	6'	68"	1W☒⊗240F-72	13	46 lbs	☉
	7'	86.75"	1W☒⊗240F-84	17	54 lbs	☉
	8'	95.5"	1W☒⊗240F-96	19	73 lbs	☉
	9'	105.5"	1W☒⊗240F-108	21	104 lbs	☉
	10'	114.75"	1W☒⊗240F-120	23	113 lbs	☉
	11'	133.5"	1W☒⊗240F-132	27	127 lbs	☉
	4' HEIGHT	12'	143"	1W☒⊗240F-144	29	142 lbs
13'		152.25"	1W☒⊗240F-156	31	153 lbs	☉
14'		171"	1W☒⊗240F-168	35	162 lbs	☉
15'		180.25"	1W☒⊗240F-180	37	171 lbs	☉
16'		189.75"	1W☒⊗240F-192	39	182 lbs	☉
3.5'		40"	1W☒⊗246F-42	7	37 lbs	☉
4'		49.5"	1W☒⊗246F-48	9	40 lbs	☉
5'		58.75"	1W☒⊗246F-60	11	49 lbs	☉
6'		68"	1W☒⊗246F-72	13	57 lbs	☉
7'		86.75"	1W☒⊗246F-84	17	63 lbs	☉
8'		95.5"	1W☒⊗246F-96	19	73 lbs	☉
9'		105.5"	1W☒⊗246F-108	21	110 lbs	☉
10'	114.75"	1W☒⊗246F-120	23	121 lbs	☉	

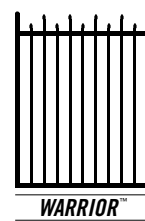
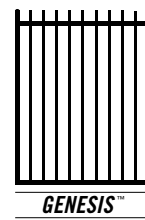
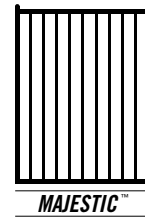
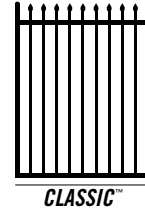

ADDITIONAL 4', 5' & 6' HEIGHTS CONTINUED ON NEXT PAGE

Effective: 01/06/15

MONTAGE PLUS® | 2-RAIL SINGLE SWING GATES

4" AIR GAP | FLUSH BOTTOM | GATE HARDWARE SOLD SEPARATELY

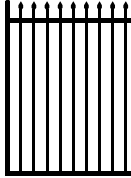
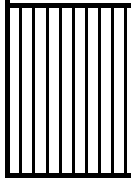
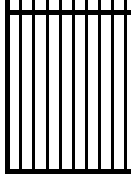
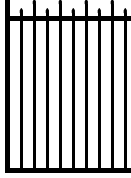
	OPENING	LEAF WIDTH	ITEM NUMBER	PICKET QTY	WEIGHT	STOCKING		
4' HEIGHT	11'	133.5"	1W☒Ⓞ246F-132	27	138 lbs	☉	 CLASSIC™	
	12'	143"	1W☒Ⓞ246F-144	29	155 lbs	☉		
	13'	152.25"	1W☒Ⓞ246F-156	31	166 lbs	☉		
	14'	171"	1W☒Ⓞ246F-168	35	176 lbs	☉		
	15'	180.25"	1W☒Ⓞ246F-180	37	186 lbs	☉		
	16'	189.75"	1W☒Ⓞ246F-192	39	197 lbs	☉		
5' HEIGHT	3.5'	40"	1W☒Ⓞ258F-42	7	46 lbs	☉	 MAJESTIC™	
	4'	49.5"	1W☒Ⓞ258F-48	9	49 lbs	☉		
	5'	58.75"	1W☒Ⓞ258F-60	11	59 lbs	☉		
	6'	68"	1W☒Ⓞ258F-72	13	69 lbs	☉		
	7'	86.75"	1W☒Ⓞ258F-84	17	75 lbs	☉		
	8'	95.5"	1W☒Ⓞ258F-96	19	88 lbs	☉		
	9'	105.5"	1W☒Ⓞ258F-108	21	127 lbs	☉		
	10'	114.75"	1W☒Ⓞ258F-120	23	140 lbs	☉		
	11'	133.5"	1W☒Ⓞ258F-132	27	161 lbs	☉		
	12'	143"	1W☒Ⓞ258F-144	29	181 lbs	☉		
6' HEIGHT	13'	152.25"	1W☒Ⓞ258F-156	31	192 lbs	☉	 GENESIS™	
	14'	171"	1W☒Ⓞ258F-168	35	204 lbs	☉		
	15'	180.25"	1W☒Ⓞ258F-180	37	216 lbs	☉		
	16'	189.75"	1W☒Ⓞ258F-192	39	227 lbs	☉		
	3.5'	40"	1W☒Ⓞ270F-42	7	54 lbs	☉		 WARRIOR™
	4'	49.5"	1W☒Ⓞ270F-48	9	58 lbs	☉		
	5'	58.75"	1W☒Ⓞ270F-60	11	69 lbs	☉		
	6'	68"	1W☒Ⓞ270F-72	13	80 lbs	☉		
	7'	86.75"	1W☒Ⓞ270F-84	17	88 lbs	☉		
	8'	95.5"	1W☒Ⓞ270F-96	19	104 lbs	☉		
9'	105.5"	1W☒Ⓞ270F-108	21	144 lbs	☉			
10'	114.75"	1W☒Ⓞ270F-120	23	159 lbs	☉			
11'	133.5"	1W☒Ⓞ270F-132	27	183 lbs	☉			
12'	143"	1W☒Ⓞ270F-144	29	206 lbs	☉			
13'	152.25"	1W☒Ⓞ270F-156	31	220 lbs	☉			
14'	171"	1W☒Ⓞ270F-168	35	233 lbs	☉			
15'	180.25"	1W☒Ⓞ270F-180	37	246 lbs	☉			
16'	189.75"	1W☒Ⓞ270F-192	39	258 lbs	☉			

☒ = FENCE STYLES AVAILABLE | C = Classic M = Majestic G = Genesis W = Warrior

Ⓞ = COLOR OPTIONS AVAILABLE | B = Black N = Bronze

☉ = NON-STOCKED PRODUCT

For details, see Ameristar's Sales Policy in the catalog guide.

Effective: 01/06/15

TO PLACE YOUR ORDER CALL 888-333-3422 | VISIT AMERISTARFENCE.COM

AMERISTAR
 ASSA ABLOY

MONTAGE PLUS® | 2-RAIL SINGLE SWING GATES

3" AIR GAP | FLUSH BOTTOM | GATE HARDWARE SOLD SEPARATELY

	OPENING	LEAF WIDTH	ITEM NUMBER	PICKET QTY	WEIGHT	STOCKING
3' HEIGHT	3.5'	40"	1R☒ⓧ234F-42	9	30 lbs	⊙
	4'	49.5"	1R☒ⓧ234F-48	12	34 lbs	⊙
	5'	58.75"	1R☒ⓧ234F-60	14	40 lbs	⊙
	6'	68"	1R☒ⓧ234F-72	17	46 lbs	⊙
	7'	86.75"	1R☒ⓧ234F-84	22	54 lbs	⊙
	8'	95.5"	1R☒ⓧ234F-96	24	60 lbs	⊙
3.5' HEIGHT	3.5'	40"	1R☒ⓧ240F-42	9	34 lbs	⊙
	4'	49.5"	1R☒ⓧ240F-48	12	39 lbs	⊙
	5'	58.75"	1R☒ⓧ240F-60	14	46 lbs	⊙
	6'	68"	1R☒ⓧ240F-72	17	52 lbs	⊙
	7'	86.75"	1R☒ⓧ240F-84	22	61 lbs	⊙
	8'	95.5"	1R☒ⓧ240F-96	24	68 lbs	⊙
4' HEIGHT	3.5'	40"	1R☒ⓧ246F-42	9	39 lbs	⊙
	4'	49.5"	1R☒ⓧ246F-48	12	42 lbs	⊙
	5'	58.75"	1R☒ⓧ246F-60	14	53 lbs	⊙
	6'	68"	1R☒ⓧ246F-72	17	61 lbs	⊙
	7'	86.75"	1R☒ⓧ246F-84	22	69 lbs	⊙
	8'	95.5"	1R☒ⓧ246F-96	24	80 lbs	⊙

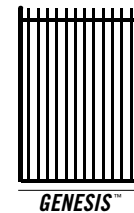
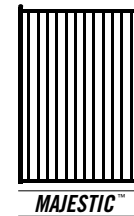
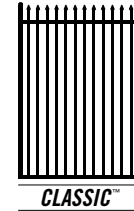

☒ = FENCE STYLES AVAILABLE | C = Classic M = Majestic G = Genesis

ⓧ = COLOR OPTIONS AVAILABLE | B = Black N = Bronze

⊙ = NON-STOCKED PRODUCT

For details, see Ameristar's Sales Policy in the catalog guide.

Notes: Genesis panels are packaged with BLACK picket plugs for black & bronze.

Effective: 01/06/15

MONTAGE PLUS® | 2-RAIL SINGLE SWING GATES

3" AIR GAP | FLUSH BOTTOM | GATE HARDWARE SOLD SEPARATELY

	OPENING	LEAF WIDTH	ITEM NUMBER	PICKET QTY	WEIGHT	STOCKING
5' HEIGHT	3.5'	40"	1R☒Ⓞ258F-42	9	48 lbs	☉
	4'	49.5"	1R☒Ⓞ258F-48	12	51 lbs	☉
	5'	58.75"	1R☒Ⓞ258F-60	14	64 lbs	☉
	6'	68"	1R☒Ⓞ258F-72	17	74 lbs	☉
	7'	86.75"	1R☒Ⓞ258F-84	22	83 lbs	☉
6' HEIGHT	3.5'	40"	1R☒Ⓞ270F-42	9	56 lbs	☉
	4'	49.5"	1R☒Ⓞ270F-48	12	60 lbs	☉
	5'	58.75"	1R☒Ⓞ270F-60	14	75 lbs	☉
	6'	68"	1R☒Ⓞ270F-72	17	87 lbs	☉
	7'	86.75"	1R☒Ⓞ270F-84	22	97 lbs	☉
	8'	95.5"	1R☒Ⓞ270F-96	24	113 lbs	☉

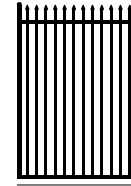

CLASSIC™

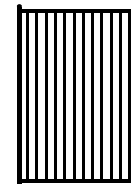

MAJESTIC™

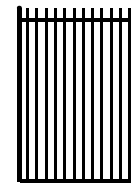

GENESIS™

☒ = FENCE STYLES AVAILABLE | C = Classic M = Majestic G = Genesis

Ⓞ = COLOR OPTIONS AVAILABLE | B = Black N = Bronze

☉ = NON-STOCKED PRODUCT

For details, see Ameristar's Sales Policy in the catalog guide.

Notes: Genesis panels are packaged with BLACK picket plugs for black & bronze.

Effective: 01/06/15

MONTAGE PLUS® | 3-RAIL SINGLE SWING GATES

4" AIR GAP | STANDARD BOTTOM | GATE HARDWARE SOLD SEPARATELY

	OPENING	LEAF WIDTH	ITEM NUMBER	PICKET QTY	WEIGHT	STOCKING
3' HEIGHT	3.5'	40"	1W☒☒334-42	7	30 lbs	☉
	4'	49.5"	1W☒☒334-48	9	36 lbs	☉
	5'	58.75"	1W☒☒334-60	11	41 lbs	☉
	6'	68"	1W☒☒334-72	13	47 lbs	☉
	7'	86.75"	1W☒☒334-84	17	57 lbs	☉
	8'	95.5"	1W☒☒334-96	19	62 lbs	☉
	9'	105.5"	1W☒☒334-108	21	100 lbs	☉
	10'	114.75"	1W☒☒334-120	23	123 lbs	☉
	11'	133.5"	1W☒☒334-132	27	138 lbs	☉
	12'	143"	1W☒☒334-144	29	153 lbs	☉
	13'	152.25"	1W☒☒334-156	31	164 lbs	☉
	14'	171"	1W☒☒334-168	35	176 lbs	☉
3.5' HEIGHT	15'	180.25"	1W☒☒334-180	37	189 lbs	☉
	16'	189.75"	1W☒☒334-192	39	202 lbs	☉
	3.5'	40"	1W☒☒340-42	7	34 lbs	☉
	4'	49.5"	1W☒☒340-48	9	40 lbs	☉
	5'	58.75"	1W☒☒340-60	11	46 lbs	☉
	6'	68"	1W☒☒340-72	13	47 lbs	☉
	7'	86.75"	1W☒☒340-84	17	62 lbs	☉
	8'	95.5"	1W☒☒340-96	19	68 lbs	☉
	9'	105.5"	1W☒☒340-108	21	115 lbs	☉
	10'	114.75"	1W☒☒340-120	23	133 lbs	☉
	11'	133.5"	1W☒☒340-132	27	150 lbs	☉
	4' HEIGHT	12'	143"	1W☒☒340-144	29	167 lbs
13'		152.25"	1W☒☒340-156	31	179 lbs	☉
14'		171"	1W☒☒340-168	35	191 lbs	☉
15'		180.25"	1W☒☒340-180	37	204 lbs	☉
16'		189.75"	1W☒☒340-192	39	217 lbs	☉
3.5'		40"	1W☒☒346-42	7	41 lbs	☉
4'		49.5"	1W☒☒346-48	9	44 lbs	MB
5'		58.75"	1W☒☒346-60	11	54 lbs	☉
6'		68"	1W☒☒346-72	13	63 lbs	☉
7'		86.75"	1W☒☒346-84	17	70 lbs	☉
8'	95.5"	1W☒☒346-96	19	82 lbs	☉	
9'	105.5"	1W☒☒346-108	21	130 lbs	☉	
10'	114.75"	1W☒☒346-120	23	143 lbs	☉	

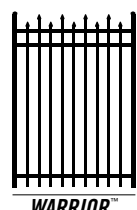
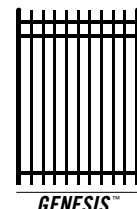
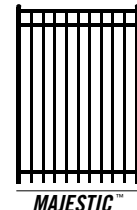
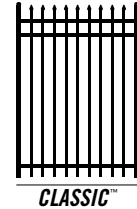

ADDITIONAL 4', 5' & 6' HEIGHTS CONTINUED ON NEXT PAGE

Effective: 01/06/15

MONTAGE PLUS® | 3-RAIL SINGLE SWING GATES

4" AIR GAP | STANDARD BOTTOM | GATE HARDWARE SOLD SEPARATELY

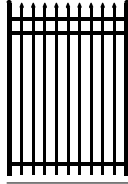
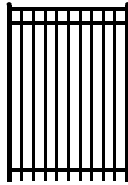
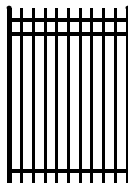
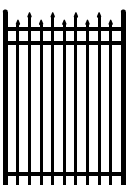
	OPENING	LEAF WIDTH	ITEM NUMBER	PICKET QTY	WEIGHT	STOCKING		
4' HEIGHT	11'	133.5"	1W☒Ⓞ 346-132	27	162 lbs	☉	 CLASSIC™	
	12'	143"	1W☒Ⓞ 346-144	29	181 lbs	☉		
	13'	152.25"	1W☒Ⓞ 346-156	31	194 lbs	☉		
	14'	171"	1W☒Ⓞ 346-168	35	206 lbs	☉		
	15'	180.25"	1W☒Ⓞ 346-180	37	219 lbs	☉		
	16'	189.75"	1W☒Ⓞ 346-192	39	232 lbs	☉		
5' HEIGHT	3.5'	40"	1W☒Ⓞ 358-42	7	49 lbs	☉	 MAJESTIC™	
	4'	49.5"	1W☒Ⓞ 358-48	9	53 lbs	☉		
	5'	58.75"	1W☒Ⓞ 358-60	11	64 lbs	☉		
	6'	68"	1W☒Ⓞ 358-72	13	74 lbs	☉		
	7'	86.75"	1W☒Ⓞ 358-84	17	82 lbs	☉		
	8'	95.5"	1W☒Ⓞ 358-96	19	97 lbs	☉		
	9'	105.5"	1W☒Ⓞ 358-108	21	159 lbs	☉		
	10'	114.75"	1W☒Ⓞ 358-120	23	162 lbs	☉		
	11'	133.5"	1W☒Ⓞ 358-132	27	185 lbs	☉		
	12'	143"	1W☒Ⓞ 358-144	29	208 lbs	☉		
6' HEIGHT	13'	152.25"	1W☒Ⓞ 358-156	31	222 lbs	☉	 GENESIS™	
	14'	171"	1W☒Ⓞ 358-168	35	235 lbs	☉		
	15'	180.25"	1W☒Ⓞ 358-180	37	249 lbs	☉		
	16'	189.75"	1W☒Ⓞ 358-192	39	262 lbs	☉		
	3.5'	40"	1W☒Ⓞ 370-42	7	57 lbs	☉		 WARRIOR™
	4'	49.5"	1W☒Ⓞ 370-48	9	62 lbs	MB GB		
	5'	58.75"	1W☒Ⓞ 370-60	11	74 lbs	MB		
	6'	68"	1W☒Ⓞ 370-72	13	87 lbs	☉		
	7'	86.75"	1W☒Ⓞ 370-84	17	95 lbs	☉		
	8'	95.5"	1W☒Ⓞ 370-96	19	112 lbs	☉		
9'	105.5"	1W☒Ⓞ 370-108	21	161 lbs	☉			
10'	114.75"	1W☒Ⓞ 370-120	23	181 lbs	☉			
11'	133.5"	1W☒Ⓞ 370-132	27	207 lbs	☉			
12'	143"	1W☒Ⓞ 370-144	29	233 lbs	☉			
13'	152.25"	1W☒Ⓞ 370-156	31	248 lbs	☉			
14'	171"	1W☒Ⓞ 370-168	35	263 lbs	☉			
15'	180.25"	1W☒Ⓞ 370-180	37	279 lbs	☉			
16'	189.75"	1W☒Ⓞ 370-192	39	294 lbs	☉			

☒ = FENCE STYLES AVAILABLE | **C** = Classic **M** = Majestic **G** = Genesis **W** = Warrior

Ⓞ = COLOR OPTIONS AVAILABLE | **B** = Black **N** = Bronze

☉ = NON-STOCKED PRODUCT

For details, see Ameristar's Sales Policy in the catalog guide.

Effective: 01/06/15

TO PLACE YOUR ORDER CALL 888-333-3422 | VISIT AMERISTARFENCE.COM

AMERISTAR
ASSA ABLOY

MONTAGE PLUS® | 3-RAIL SINGLE SWING GATES

3" AIR GAP | STANDARD BOTTOM | GATE HARDWARE SOLD SEPARATELY

	OPENING	LEAF WIDTH	ITEM NUMBER	PICKET QTY	WEIGHT	STOCKING
3' HEIGHT	3.5'	40"	1R☒⊗334-42	9	33 lbs	☉
	4'	49.5"	1R☒⊗334-48	12	35 lbs	☉
	5'	58.75"	1R☒⊗334-60	14	46 lbs	☉
	6'	68"	1R☒⊗334-72	17	53 lbs	☉
	7'	86.75"	1R☒⊗334-84	22	62 lbs	☉
	8'	95.5"	1R☒⊗334-96	24	69 lbs	☉
3.5' HEIGHT	3.5'	40"	1R☒⊗340-42	9	37 lbs	☉
	4'	49.5"	1R☒⊗340-48	12	39 lbs	☉
	5'	58.75"	1R☒⊗340-60	14	51 lbs	☉
	6'	68"	1R☒⊗340-72	17	59 lbs	☉
	7'	86.75"	1R☒⊗340-84	22	69 lbs	☉
	8'	95.5"	1R☒⊗340-96	24	77 lbs	☉
4' HEIGHT	3.5'	40"	1R☒⊗346-42	9	43 lbs	☉
	4'	49.5"	1R☒⊗346-48	12	47 lbs	☉
	5'	58.75"	1R☒⊗346-60	14	58 lbs	☉
	6'	68"	1R☒⊗346-72	17	67 lbs	☉
	7'	86.75"	1R☒⊗346-84	22	76 lbs	☉
	8'	95.5"	1R☒⊗346-96	24	88 lbs	☉

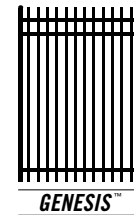
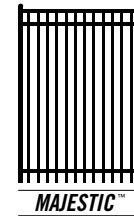
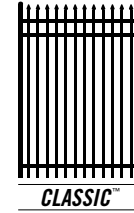

5' & 6' HEIGHTS CONTINUED ON NEXT PAGE

☒ = FENCE STYLES AVAILABLE | C = Classic M = Majestic G = Genesis

⊗ = COLOR OPTIONS AVAILABLE | B = Black N = Bronze

☉ = NON-STOCKED PRODUCT

For details, see Ameristar's Sales Policy in the catalog guide.

Notes: Genesis panels are packaged with BLACK picket plugs for black & bronze.

Effective: 01/06/15

MONTAGE PLUS® | 3-RAIL SINGLE SWING GATES

3" AIR GAP | STANDARD BOTTOM | GATE HARDWARE SOLD SEPARATELY

	OPENING	LEAF WIDTH	ITEM NUMBER	PICKET QTY	WEIGHT	STOCKING
5' HEIGHT	3.5'	40"	1R☒Ⓞ358-42	9	51 lbs	Ⓞ
	4'	49.5"	1R☒Ⓞ358-48	12	55 lbs	Ⓞ
	5'	58.75"	1R☒Ⓞ358-60	14	69 lbs	Ⓞ
	6'	68"	1R☒Ⓞ358-72	17	80 lbs	Ⓞ
	7'	86.75"	1R☒Ⓞ358-84	22	90 lbs	Ⓞ
6' HEIGHT	8'	95.5"	1R☒Ⓞ358-96	24	105 lbs	Ⓞ
	3.5'	40"	1R☒Ⓞ370-42	9	60 lbs	Ⓞ
	4'	49.5"	1R☒Ⓞ370-48	12	64 lbs	Ⓞ
	5'	58.75"	1R☒Ⓞ370-60	14	80 lbs	Ⓞ
	6'	68"	1R☒Ⓞ370-72	17	93 lbs	Ⓞ
	7'	86.75"	1R☒Ⓞ370-84	22	104 lbs	Ⓞ
	8'	95.5"	1R☒Ⓞ370-96	24	118 lbs	Ⓞ

☒ = FENCE STYLES AVAILABLE | **C** = Classic **M** = Majestic **G** = Genesis

Ⓞ = COLOR OPTIONS AVAILABLE | **B** = Black **N** = Bronze

Ⓞ = NON-STOCKED PRODUCT

For details, see Ameristar's Sales Policy in the catalog guide.

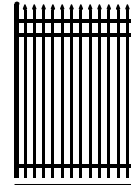

CLASSIC™

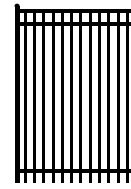

MAJESTIC™

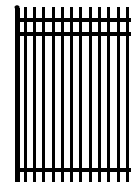

GENESIS™

Notes: Genesis panels are packaged with BLACK picket plugs for black & bronze.

Effective: 01/06/15

MONTAGE PLUS® | 3-RAIL SINGLE SWING GATES

4" AIR GAP | FLUSH BOTTOM | GATE HARDWARE SOLD SEPARATELY

	OPENING	LEAF WIDTH	ITEM NUMBER	PICKET QTY	WEIGHT	STOCKING
3' HEIGHT	3.5'	40"	1W☒⊗334F-42	7	60 lbs	⊙
	4'	49.5"	1W☒⊗334F-48	9	36 lbs	⊙
	5'	58.75"	1W☒⊗334F-60	11	41 lbs	⊙
	6'	68"	1W☒⊗334F-72	13	47 lbs	⊙
	7'	86.75"	1W☒⊗334F-84	17	57 lbs	⊙
	8'	95.5"	1W☒⊗334F-96	19	62 lbs	⊙
	9'	105.5"	1W☒⊗334F-108	21	100 lbs	⊙
	10'	114.75"	1W☒⊗334F-120	23	123 lbs	⊙
	11'	133.5"	1W☒⊗334F-132	27	138 lbs	⊙
	12'	143"	1W☒⊗334F-144	29	153 lbs	⊙
	13'	152.25"	1W☒⊗334F-156	31	164 lbs	⊙
	14'	171"	1W☒⊗334F-168	35	176 lbs	⊙
3.5' HEIGHT	15'	180.25"	1W☒⊗334F-180	37	189 lbs	⊙
	16'	189.75"	1W☒⊗334F-192	39	202 lbs	⊙
	3.5'	40"	1W☒⊗340F-42	7	34 lbs	⊙
	4'	49.5"	1W☒⊗340F-48	9	40 lbs	⊙
	5'	58.75"	1W☒⊗340F-60	11	46 lbs	⊙
	6'	68"	1W☒⊗340F-72	13	47 lbs	⊙
	7'	86.75"	1W☒⊗340F-84	17	62 lbs	⊙
	8'	95.5"	1W☒⊗340F-96	19	68 lbs	⊙
	9'	105.5"	1W☒⊗340F-108	21	115 lbs	⊙
	10'	114.75"	1W☒⊗340F-120	23	133 lbs	⊙
	11'	133.5"	1W☒⊗340F-132	27	150 lbs	⊙
	12'	143"	1W☒⊗340F-144	29	167 lbs	⊙
13'	152.25"	1W☒⊗340F-156	31	179 lbs	⊙	
14'	171"	1W☒⊗340F-168	35	191 lbs	⊙	
15'	180.25"	1W☒⊗340F-180	37	204 lbs	⊙	
16'	189.75"	1W☒⊗340F-192	39	217 lbs	⊙	

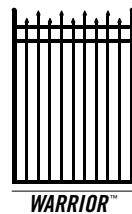
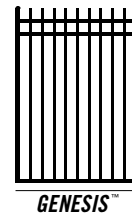
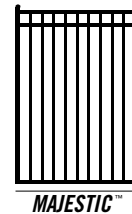
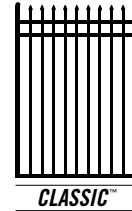

4', 4.5', 5' & 6' HEIGHTS CONTINUED ON NEXT PAGES

☒ = FENCE STYLES AVAILABLE | C = Classic M = Majestic G = Genesis W = Warrior

⊗ = COLOR OPTIONS AVAILABLE | B = Black N = Bronze

⊙ = NON-STOCKED PRODUCT

For details, see Ameristar's Sales Policy in the catalog guide.

Notes: Genesis panels are packaged with BLACK picket plugs for black & bronze.

Effective: 01/06/15

MONTAGE PLUS® | 3-RAIL SINGLE SWING GATES

4" AIR GAP | FLUSH BOTTOM | GATE HARDWARE SOLD SEPARATELY

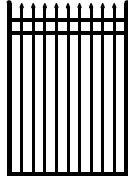
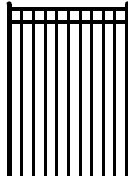
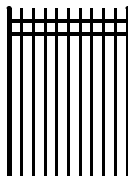
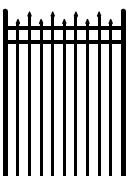
	OPENING	LEAF WIDTH	ITEM NUMBER	PICKET QTY	WEIGHT	STOCKING	
4' HEIGHT	3.5'	40"	1W☒⊗346F-42	7	41 lbs	⊙	 CLASSIC™
	4'	49.5"	1W☒⊗346F-48	9	44 lbs	⊙	
	5'	58.75"	1W☒⊗346F-60	11	54 lbs	⊙	
	6'	68"	1W☒⊗346F-72	13	63 lbs	⊙	 MAJESTIC™
	7'	86.75"	1W☒⊗346F-84	17	70 lbs	⊙	
	8'	95.5"	1W☒⊗346F-96	19	82 lbs	⊙	
	9'	105.5"	1W☒⊗346F-108	21	130 lbs	⊙	
	10'	114.75"	1W☒⊗346F-120	23	143 lbs	⊙	 GENESIS™
	11'	133.5"	1W☒⊗346F-132	27	162 lbs	⊙	
	12'	143"	1W☒⊗346F-144	29	181 lbs	⊙	
13'	152.25"	1W☒⊗346F-156	31	194 lbs	⊙		
14'	171"	1W☒⊗346F-168	35	206 lbs	⊙		
15'	180.25"	1W☒⊗346F-180	37	219 lbs	⊙		
4.5' HEIGHT	16'	189.75"	1W☒⊗346F-192	39	232 lbs	⊙	 WARRIOR™
	3.5'	40"	1WM⊗354F-42*	7	47 lbs	⊙	
	4'	49.5"	1WM⊗354F-48*	9	51 lbs	⊙	
	5'	58.75"	1WM⊗354F-60*	11	62 lbs	⊙	
	6'	68"	1WM⊗354F-72*	13	72 lbs	⊙	
	7'	86.75"	1WM⊗354F-84*	17	80 lbs	⊙	
	8'	95.5"	1WM⊗354F-96*	19	95 lbs	⊙	
	9'	105.5"	1WM⊗354F-108*	21	147 lbs	⊙	
	10'	114.75"	1WM⊗354F-120*	23	155 lbs	⊙	
	11'	133.5"	1WM⊗354F-132*	27	176 lbs	⊙	
12'	143"	1WM⊗354F-144*	29	197 lbs	⊙		
13'	152.25"	1WM⊗354F-156*	31	210 lbs	⊙		
14'	171"	1WM⊗354F-168*	35	223 lbs	⊙		
15'	180.25"	1WM⊗354F-180*	37	236 lbs	⊙		
16'	189.75"	1WM⊗354F-192*	39	249 lbs	⊙		

5' & 6' HEIGHTS CONTINUED ON NEXT PAGES

☒ = FENCE STYLES AVAILABLE | C = Classic M = Majestic G = Genesis W = Warrior

⊗ = COLOR OPTIONS AVAILABLE | B = Black N = Bronze

⊙ = NON-STOCKED PRODUCT

For details, see Ameristar's Sales Policy in the catalog guide.

* 4.5' flush bottom gates available in Majestic only

Notes: Genesis panels are packaged with BLACK picket plugs for black & bronze.

Effective: 01/06/15

MONTAGE PLUS® | 3-RAIL SINGLE SWING GATES

4" AIR GAP | FLUSH BOTTOM | GATE HARDWARE SOLD SEPARATELY

OPENING	LEAF WIDTH	ITEM NUMBER	PICKET QTY	WEIGHT	STOCKING
3.5'	40"	1W☒⊗358F-42	7	49 lbs	☉
4'	49.5"	1W☒⊗358F-48	9	53 lbs	☉
5'	58.75"	1W☒⊗358F-60	11	64 lbs	☉
6'	68"	1W☒⊗358F-72	13	74 lbs	☉
7'	86.75"	1W☒⊗358F-84	17	82 lbs	☉
8'	95.5"	1W☒⊗358F-96	19	97 lbs	☉
9'	105.5"	1W☒⊗358F-108	21	159 lbs	☉
10'	114.75"	1W☒⊗358F-120	23	162 lbs	☉
11'	133.5"	1W☒⊗358F-132	27	185 lbs	☉
12'	143"	1W☒⊗358F-144	29	208 lbs	☉
13'	152.25"	1W☒⊗358F-156	31	222 lbs	☉
14'	171"	1W☒⊗358F-168	35	235 lbs	☉
15'	180.25"	1W☒⊗358F-180	37	249 lbs	☉
16'	189.75"	1W☒⊗358F-192	39	262 lbs	☉

5'
HEIGHT

6' HEIGHTS CONTINUED ON FOLLOWING PAGE

☒ = FENCE STYLES AVAILABLE | **C** = Classic **M** = Majestic **G** = Genesis **W** = Warrior
 ⊗ = COLOR OPTIONS AVAILABLE | **B** = Black **N** = Bronze
 ☉ = NON-STOCKED PRODUCT
 For details, see Ameristar's Sales Policy in the catalog guide.

Notes: Genesis panels are packaged with BLACK picket plugs for black & bronze.

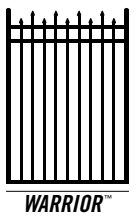
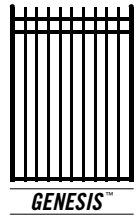
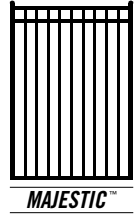
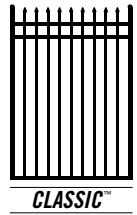

Effective: 01/06/15

MONTAGE PLUS® | 3-RAIL SINGLE SWING GATES

4" AIR GAP | FLUSH BOTTOM | GATE HARDWARE SOLD SEPARATELY

OPENING	LEAF WIDTH	ITEM NUMBER	PICKET QTY	WEIGHT	STOCKING
3.5'	40"	1W☒ⓧ370F-42	7	57 lbs	⊙
4'	49.5"	1W☒ⓧ370F-48	9	62 lbs	⊙
5'	58.75"	1W☒ⓧ370F-60	11	74 lbs	⊙
6'	68"	1W☒ⓧ370F-72	13	87 lbs	⊙
7'	86.75"	1W☒ⓧ370F-84	17	95 lbs	⊙
8'	95.5"	1W☒ⓧ370F-96	19	112 lbs	⊙
9'	105.5"	1W☒ⓧ370F-108	21	161 lbs	⊙
10'	114.75"	1W☒ⓧ370F-120	23	181 lbs	⊙
11'	133.5"	1W☒ⓧ370F-132	27	207 lbs	⊙
12'	143"	1W☒ⓧ370F-144	29	233 lbs	⊙
13'	152.25"	1W☒ⓧ370F-156	31	248 lbs	⊙
14'	171"	1W☒ⓧ370F-168	35	263 lbs	⊙
15'	180.25"	1W☒ⓧ370F-180	37	279 lbs	⊙
16'	189.75"	1W☒ⓧ370F-192	39	294 lbs	⊙

6'
HEIGHT

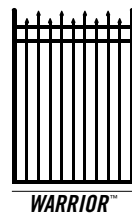
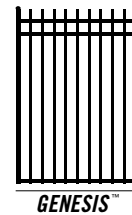
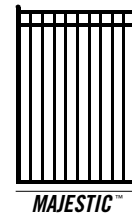
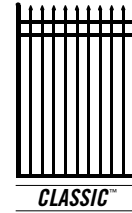

☒ = FENCE STYLES AVAILABLE | **C** = Classic **M** = Majestic **G** = Genesis **W** = Warrior

ⓧ = COLOR OPTIONS AVAILABLE | **B** = Black **N** = Bronze

⊙ = NON-STOCKED PRODUCT

For details, see Ameristar's Sales Policy in the catalog guide.

Notes: Genesis panels are packaged with BLACK picket plugs for black & bronze.

Effective: 01/06/15

MONTAGE PLUS® | 3-RAIL SINGLE SWING GATES

3" AIR GAP | FLUSH BOTTOM | GATE HARDWARE SOLD SEPARATELY

	OPENING	LEAF WIDTH	ITEM NUMBER	PICKET QTY	WEIGHT	STOCKING
3' HEIGHT	3.5'	40"	1R☒ⓧ334F-42	9	33 lbs	⊙
	4'	49.5"	1R☒ⓧ334F-48	12	35 lbs	⊙
	5'	58.75"	1R☒ⓧ334F-60	14	46 lbs	⊙
	6'	68"	1R☒ⓧ334F-72	17	53 lbs	⊙
	7'	86.75"	1R☒ⓧ334F-84	22	62 lbs	⊙
	8'	95.5"	1R☒ⓧ334F-96	24	69 lbs	⊙
3.5' HEIGHT	3.5'	40"	1R☒ⓧ340F-42	9	37 lbs	⊙
	4'	49.5"	1R☒ⓧ340F-48	12	39 lbs	⊙
	5'	58.75"	1R☒ⓧ340F-60	14	51 lbs	⊙
	6'	68"	1R☒ⓧ340F-72	17	59 lbs	⊙
	7'	86.75"	1R☒ⓧ340F-84	22	69 lbs	⊙
	8'	95.5"	1R☒ⓧ340F-96	24	77 lbs	⊙
4' HEIGHT	3.5'	40"	1R☒ⓧ346F-42	9	43 lbs	⊙
	4'	49.5"	1R☒ⓧ346F-48	12	47 lbs	⊙
	5'	58.75"	1R☒ⓧ346F-60	14	58 lbs	⊙
	6'	68"	1R☒ⓧ346F-72	17	67 lbs	⊙
	7'	86.75"	1R☒ⓧ346F-84	22	76 lbs	⊙
	8'	95.5"	1R☒ⓧ346F-96	24	88 lbs	⊙

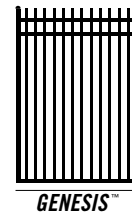
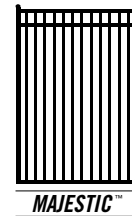
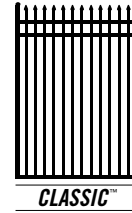

☒ = FENCE STYLES AVAILABLE | C = Classic M = Majestic G = Genesis

ⓧ = COLOR OPTIONS AVAILABLE | B = Black N = Bronze

⊙ = NON-STOCKED PRODUCT

For details, see Ameristar's Sales Policy in the catalog guide.

Notes: Genesis panels are packaged with BLACK picket plugs for black & bronze.

Effective: 01/06/15

MONTAGE PLUS® | 3-RAIL SINGLE SWING GATES

3" AIR GAP | FLUSH BOTTOM | GATE HARDWARE SOLD SEPARATELY

	OPENING	LEAF WIDTH	ITEM NUMBER	PICKET QTY	WEIGHT	STOCKING
4.5' HEIGHT	3.5'	40"	1R M ⊗ 354F-42*	9	49 lbs	⊙
	4'	49.5"	1R M ⊗ 354F-48*	12	53 lbs	⊙
	5'	58.75"	1R M ⊗ 354F-60*	14	67 lbs	⊙
	6'	68"	1R M ⊗ 354F-72*	17	78 lbs	⊙
	7'	86.75"	1R M ⊗ 354F-84*	22	88 lbs	⊙
	8'	95.5"	1R M ⊗ 354F-96*	24	103 lbs	⊙
5' HEIGHT	3.5'	40"	1R C ⊗ 358F-42	9	51 lbs	⊙
	4'	49.5"	1R C ⊗ 358F-48	12	55 lbs	⊙
	5'	58.75"	1R C ⊗ 358F-60	14	69 lbs	⊙
	6'	68"	1R C ⊗ 358F-72	17	80 lbs	⊙
	7'	86.75"	1R C ⊗ 358F-84	22	90 lbs	⊙
	8'	95.5"	1R C ⊗ 358F-96	24	105 lbs	⊙
6' HEIGHT	3.5'	40"	1R G ⊗ 370F-42	9	60 lbs	⊙
	4'	49.5"	1R G ⊗ 370F-48	12	64 lbs	⊙
	5'	58.75"	1R G ⊗ 370F-60	14	80 lbs	⊙
	6'	68"	1R G ⊗ 370F-72	17	93 lbs	⊙
	7'	86.75"	1R G ⊗ 370F-84	22	104 lbs	⊙
	8'	95.5"	1R G ⊗ 370F-96	24	118 lbs	⊙

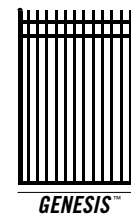
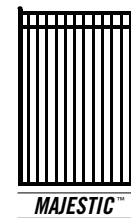
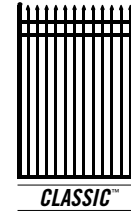

⊠ = FENCE STYLES AVAILABLE | **C** = Classic **M** = Majestic **G** = Genesis

⊗ = COLOR OPTIONS AVAILABLE | **B** = Black **N** = Bronze

⊙ = NON-STOCKED PRODUCT

For details, see Ameristar's Sales Policy in the catalog guide.

* 4.5' flush bottom gates available in Majestic only

Notes: Genesis panels are packaged with BLACK picket plugs for black & bronze.

Effective: 01/06/15

MONTAGE PLUS® | SINGLE SWING STEEL ARCHED GATE SPECIFICATIONS

1.75"sq x 14ga STEEL GATE ENDS | 1.4375" x 1.5" x 14ga RAILS | .75"sq x 18ga PICKETS | 3.5' - 6' NOMINAL OPENINGS

SINGLE SWING
DIMENSIONAL DRAWING

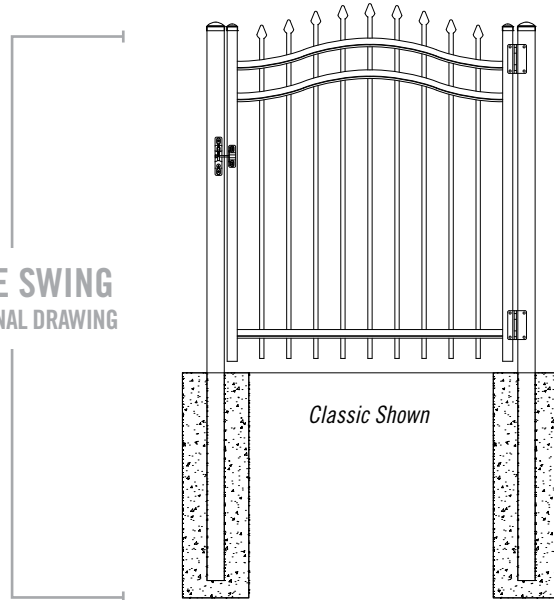

SINGLE SWING
ARCHED
HARDWARE KITS &
POST INTERSPACES

SGBSX25 / SGBSX3
FORK LATCH / BOX
HINGE KITS

CGBS-25
CGBS-3 / CGBS-4
COMMERCIAL HINGE
WITH STRONG ARM

HGBS-25
HGBS-3 / HGBS-4
HEAVY COMMERCIAL
HINGE KITS

OPENING	LEAF WIDTH*	HC	LC	P _S	HC	LC	P _S	HC	LC	P _S
3.5'	40"	2"	2"	44"	1"	3"	44"	1.25"	3"	44.25"
4'	49.5"	2"	2"	53.5"	1"	3"	53.5"	1.25"	3"	53.75"
5'	58.75"	2"	2"	62.75"	1"	3"	62.75"	1.25"	3"	63"
6'	68"	2"	2"	72"	1"	3"	72"	1.25"	3"	72.25"

W = width* | HC = hinge clearance | LC = latch clearance | P_S = gate post spacing**
 * From outside to outside | ** From inside to inside

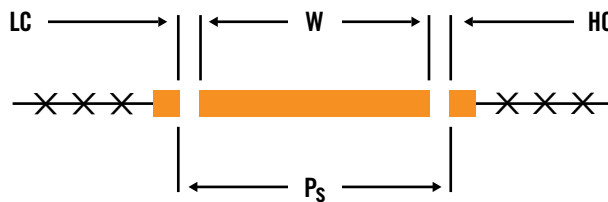

Effective: 01/06/15

MONTAGE PLUS® | DOUBLE SWING STEEL ARCHED GATE SPECIFICATIONS

1.75"sq x 14ga STEEL GATE ENDS | 1.4375" x 1.5" x 14ga RAILS | .75"sq x 18ga PICKETS | 7' - 14' NOMINAL OPENINGS

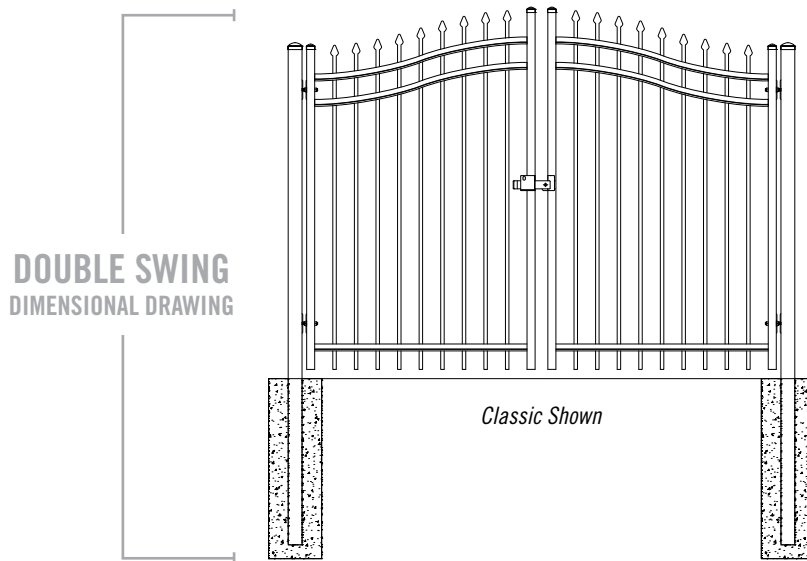

DOUBLE SWING HARDWARE KITS & POST INTERSPACES

OPENING	LEAF WIDTH*	SGBDX FORK LATCH / BOX HINGE KITS			CGBD COMMERCIAL HINGE WITH STRONG ARM			HGBD HEAVY COMMERCIAL HINGE KITS		
		HC	LC	P _d	HC	LC	P _d	HC	LC	P _d
7'	40"	2"	2"	86"	1"	2"	84"	1.25"	2"	84.5"
8'	49.5"	2"	2"	105"	1"	2"	103"	1.25"	2"	103.5"
10'	58.75"	2"	2"	123.5"	1"	2"	121.5"	1.25"	2"	122"
12'	68"	2"	2"	142"	1"	2"	140"	1.25"	2"	140.5"
14'	86.75"	2"	2"	179.5"	1"	2"	177.5"	1.25"	2"	178"

W = width (x2)* | HC = hinge clearance (x2) | LC = latch clearance | P_d = gate post spacing**
 * From outside to outside | ** From inside to inside

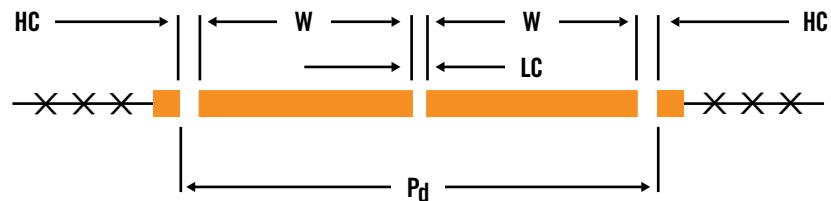

Effective: 01/06/15

MONTAGE PLUS® | 2-RAIL SINGLE SWING ARCHED GATES

4" AIR GAP | STANDARD BOTTOM | GATE HARDWARE SOLD SEPARATELY

	OPENING	LEAF WIDTH	ITEM NUMBER	PICKET QTY	WEIGHT	STOCKING
3' HEIGHT	3.5'	40"	1W☒⊗234-42A	7	29 lbs	☉
	4'	49.5"	1W☒⊗234-48A	9	35 lbs	☉
	5'	58.75"	1W☒⊗234-60A	11	39 lbs	☉
	6'	68"	1W☒⊗234-72A	13	44 lbs	☉
3.5' HEIGHT	3.5'	40"	1W☒⊗240-42A	7	32 lbs	☉
	4'	49.5"	1W☒⊗240-48A	9	39 lbs	☉
	5'	58.75"	1W☒⊗240-60A	11	44 lbs	☉
	6'	68"	1W☒⊗240-72A	13	50 lbs	☉
4' HEIGHT	3.5'	40"	1W☒⊗246-42A	7	40 lbs	☉
	4'	49.5"	1W☒⊗246-48A	9	43 lbs	☉
	5'	58.75"	1W☒⊗246-60A	11	53 lbs	☉
	6'	68"	1W☒⊗246-72A	13	62 lbs	☉
5' HEIGHT	3.5'	40"	1W☒⊗258-42A	7	50 lbs	☉
	4'	49.5"	1W☒⊗258-48A	9	53 lbs	☉
	5'	58.75"	1W☒⊗258-60A	11	64 lbs	☉
	6'	68"	1W☒⊗258-72A	13	75 lbs	☉
6' HEIGHT	3.5'	40"	1W☒⊗270-42A	7	58 lbs	☉
	4'	49.5"	1W☒⊗270-48A	9	63 lbs	☉
	5'	58.75"	1W☒⊗270-60A	11	75 lbs	☉
	6'	68"	1W☒⊗270-72A	13	86 lbs	☉

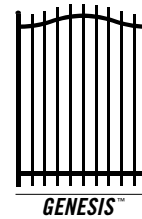
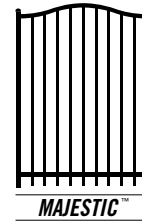
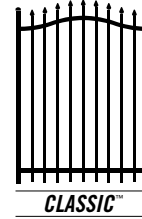

☒ = FENCE STYLES AVAILABLE | **C** = Classic **M** = Majestic **G** = Genesis

⊗ = COLOR OPTIONS AVAILABLE | **B** = Black **N** = Bronze

☉ = NON-STOCKED PRODUCT

For details, see Ameristar's Sales Policy in the catalog guide.

WARNING: Steel arched gates with EXTENDED PICKET BOTTOM exposure are NOT TO BE AUTOMATED!
 Extended picket bottom treatment does not meet ASTM standard F2200 for automated gates.

Notes: Genesis panels are packaged with BLACK picket plugs for black & bronze.

Effective: 01/06/15

MONTAGE PLUS® | 2-RAIL SINGLE SWING ARCHED GATES

4" AIR GAP | FLUSH BOTTOM | GATE HARDWARE SOLD SEPARATELY

	OPENING	LEAF WIDTH	ITEM NUMBER	PICKET QTY	WEIGHT	STOCKING
3' HEIGHT	3.5'	40"	1W☒ⓧ234F-42A	7	29 lbs	☉
	4'	49.5"	1W☒ⓧ234F-48A	9	35 lbs	☉
	5'	58.75"	1W☒ⓧ234F-60A	11	39 lbs	☉
	6'	68"	1W☒ⓧ234F-72A	13	44 lbs	☉
3.5' HEIGHT	3.5'	40"	1W☒ⓧ240F-42A	7	32 lbs	☉
	4'	49.5"	1W☒ⓧ240F-48A	9	39 lbs	☉
	5'	58.75"	1W☒ⓧ240F-60A	11	44 lbs	☉
	6'	68"	1W☒ⓧ240F-72A	13	50 lbs	☉
4' HEIGHT	3.5'	40"	1W☒ⓧ246F-42A	7	40 lbs	☉
	4'	49.5"	1W☒ⓧ246F-48A	9	43 lbs	☉
	5'	58.75"	1W☒ⓧ246F-60A	11	53 lbs	☉
	6'	68"	1W☒ⓧ246F-72A	13	62 lbs	☉
5' HEIGHT	3.5'	40"	1W☒ⓧ258F-42A	7	50 lbs	☉
	4'	49.5"	1W☒ⓧ258F-48A	9	53 lbs	☉
	5'	58.75"	1W☒ⓧ258F-60A	11	64 lbs	☉
	6'	68"	1W☒ⓧ258F-72A	13	75 lbs	☉
6' HEIGHT	3.5'	40"	1W☒ⓧ270F-42A	7	58 lbs	☉
	4'	49.5"	1W☒ⓧ270F-48A	9	63 lbs	☉
	5'	58.75"	1W☒ⓧ270F-60A	11	75 lbs	☉
	6'	68"	1W☒ⓧ270F-72A	13	86 lbs	☉

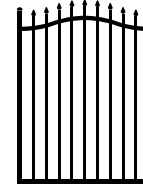

CLASSIC™

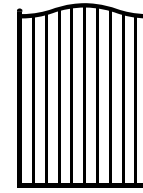

MAJESTIC™

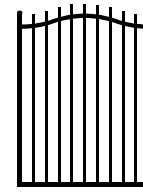

GENESIS™

☒ = FENCE STYLES AVAILABLE | **C** = Classic **M** = Majestic **G** = Genesis

ⓧ = COLOR OPTIONS AVAILABLE | **B** = Black **N** = Bronze

☉ = NON-STOCKED PRODUCT

For details, see Ameristar's Sales Policy in the catalog guide.

Notes: Genesis panels are packaged with BLACK picket plugs for black & bronze.

Effective: 01/06/15

MONTAGE PLUS® | 3-RAIL SINGLE SWING ARCHED GATES

4" AIR GAP | STANDARD BOTTOM | GATE HARDWARE SOLD SEPARATELY

	OPENING	LEAF WIDTH	ITEM NUMBER	PICKET QTY	WEIGHT	STOCKING
3' HEIGHT	3.5'	40"	1W☒⊗334-42A	7	32 lbs	☉
	4'	49.5"	1W☒⊗334-48A	9	39 lbs	☉
	5'	58.75"	1W☒⊗334-60A	11	44 lbs	☉
	6'	68"	1W☒⊗334-72A	13	51 lbs	☉
3.5' HEIGHT	3.5'	40"	1W☒⊗340-42A	7	37 lbs	☉
	4'	49.5"	1W☒⊗340-48A	9	43 lbs	☉
	5'	58.75"	1W☒⊗340-60A	11	50 lbs	☉
	6'	68"	1W☒⊗340-72A	13	51 lbs	☉
4' HEIGHT	3.5'	40"	1W☒⊗346-42A	7	44 lbs	☉
	4'	49.5"	1W☒⊗346-48A	9	48 lbs	☉
	5'	58.75"	1W☒⊗346-60A	11	58 lbs	☉
	6'	68"	1W☒⊗346-72A	13	68 lbs	☉
5' HEIGHT	3.5'	40"	1W☒⊗358-42A	7	53 lbs	☉
	4'	49.5"	1W☒⊗358-48A	9	57 lbs	☉
	5'	58.75"	1W☒⊗358-60A	11	69 lbs	☉
	6'	68"	1W☒⊗358-72A	13	80 lbs	☉
6' HEIGHT	3.5'	40"	1W☒⊗370-42A	7	62 lbs	☉
	4'	49.5"	1W☒⊗370-48A	9	67 lbs	☉
	5'	58.75"	1W☒⊗370-60A	11	80 lbs	☉
	6'	68"	1W☒⊗370-72A	13	94 lbs	☉

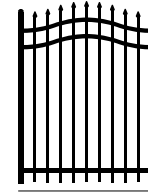

CLASSIC™

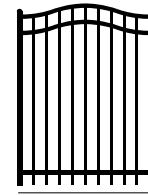

MAJESTIC™

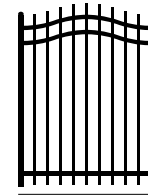

GENESIS™

☒ = FENCE STYLES AVAILABLE | C = Classic M = Majestic G = Genesis

⊗ = COLOR OPTIONS AVAILABLE | B = Black N = Bronze

☉ = NON-STOCKED PRODUCT

For details, see Ameristar's Sales Policy in the catalog guide.

WARNING: Steel arched gates with EXTENDED PICKET BOTTOM exposure are NOT TO BE AUTOMATED!
 Extended picket bottom treatment does not meet ASTM standard F2200 for automated gates.

Notes: Genesis panels are packaged with BLACK picket plugs for black & bronze.

Effective: 01/06/15

MONTAGE PLUS® | 3-RAIL SINGLE SWING ARCHED GATES

4" AIR GAP | FLUSH BOTTOM | GATE HARDWARE SOLD SEPARATELY

	OPENING	LEAF WIDTH	ITEM NUMBER	PICKET QTY	WEIGHT	STOCKING
3' HEIGHT	3.5'	40"	1W☒Ⓞ334F-42A	7	32 lbs	☉
	4'	49.5"	1W☒Ⓞ334F-48A	9	39 lbs	☉
	5'	58.75"	1W☒Ⓞ334F-60A	11	44 lbs	☉
	6'	68"	1W☒Ⓞ334F-72A	13	51 lbs	☉
3.5' HEIGHT	3.5'	40"	1W☒Ⓞ340F-42A	7	37 lbs	☉
	4'	49.5"	1W☒Ⓞ340F-48A	9	43 lbs	☉
	5'	58.75"	1W☒Ⓞ340F-60A	11	50 lbs	☉
	6'	68"	1W☒Ⓞ340F-72A	13	51 lbs	☉
4' HEIGHT	3.5'	40"	1W☒Ⓞ346F-42A	7	44 lbs	☉
	4'	49.5"	1W☒Ⓞ346F-48A	9	48 lbs	☉
	5'	58.75"	1W☒Ⓞ346F-60A	11	58 lbs	☉
	6'	68"	1W☒Ⓞ346F-72A	13	68 lbs	☉
4.5' HEIGHT	3.5'	40"	1WMⓄ354F-42A*	7	51 lbs	☉
	4'	49.5"	1WMⓄ354F-48A*	9	58 lbs	☉
	5'	58.75"	1WMⓄ354F-60A*	11	67 lbs	☉
	6'	68"	1WMⓄ354F-72A*	13	78 lbs	☉
5' HEIGHT	3.5'	40"	1W☒Ⓞ358F-42A	7	53 lbs	☉
	4'	49.5"	1W☒Ⓞ358F-48A	9	57 lbs	☉
	5'	58.75"	1W☒Ⓞ358F-60A	11	69 lbs	☉
	6'	68"	1W☒Ⓞ358F-72A	13	80 lbs	☉
6' HEIGHT	3.5'	40"	1W☒Ⓞ370F-42A	7	62 lbs	☉
	4'	49.5"	1W☒Ⓞ370F-48A	9	67 lbs	☉
	5'	58.75"	1W☒Ⓞ370F-60A	11	80 lbs	☉
	6'	68"	1W☒Ⓞ370F-72A	13	94 lbs	☉

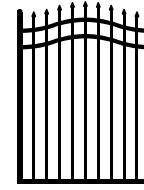

CLASSIC™

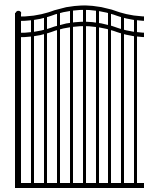

MAJESTIC™

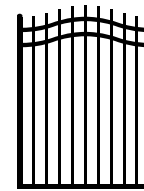

GENESIS™

☒ = FENCE STYLES AVAILABLE | C = Classic M = Majestic G = Genesis

Ⓞ = COLOR OPTIONS AVAILABLE | B = Black N = Bronze

☉ = NON-STOCKED PRODUCT

For details, see Ameristar's Sales Policy in the catalog guide.

* 4.5' flush bottom gates available in Majestic only

Notes: Genesis panels are packaged with BLACK picket plugs for black & bronze.

Effective: 01/06/15

MONTAGE PLUS® | 2-RAIL DOUBLE SWING ARCHED GATES

4" AIR GAP | STANDARD BOTTOM | GATE HARDWARE SOLD SEPARATELY

	OPENING	LEAF WIDTH	ITEM NUMBER	PICKET QTY	WEIGHT	STOCKING
3' HEIGHT	7'	40"	1W☒Ⓞ234-84HD	14	58 lbs	☉
	8'	49.5"	1W☒Ⓞ234-96HD	18	68 lbs	☉
	10'	58.75"	1W☒Ⓞ234-120HD	22	76 lbs	☉
	12'	68"	1W☒Ⓞ234-144HD	26	86 lbs	☉
	14'	86.75"	1W☒Ⓞ234-168HD	34	102 lbs	☉
3.5' HEIGHT	7'	40"	1W☒Ⓞ240-84HD	14	64 lbs	☉
	8'	49.5"	1W☒Ⓞ240-96HD	18	76 lbs	☉
	10'	58.75"	1W☒Ⓞ240-120HD	22	86 lbs	☉
	12'	68"	1W☒Ⓞ240-144HD	26	96 lbs	☉
	14'	86.75"	1W☒Ⓞ240-168HD	34	112 lbs	☉
4' HEIGHT	7'	40"	1W☒Ⓞ246-84HD	14	78 lbs	☉
	8'	49.5"	1W☒Ⓞ246-96HD	18	84 lbs	☉
	10'	58.75"	1W☒Ⓞ246-120HD	22	102 lbs	☉
	12'	68"	1W☒Ⓞ246-144HD	26	118 lbs	☉
	14'	86.75"	1W☒Ⓞ246-168HD	34	130 lbs	☉
5' HEIGHT	7'	40"	1W☒Ⓞ258-84HD	14	98 lbs	☉
	8'	49.5"	1W☒Ⓞ258-96HD	18	104 lbs	☉
	10'	58.75"	1W☒Ⓞ258-120HD	22	122 lbs	☉
	12'	68"	1W☒Ⓞ258-144HD	26	142 lbs	☉
	14'	86.75"	1W☒Ⓞ258-168HD	34	154 lbs	☉
6' HEIGHT	7'	40"	1W☒Ⓞ270-84HD	14	114 lbs	☉
	8'	49.5"	1W☒Ⓞ270-96HD	18	122 lbs	☉
	10'	58.75"	1W☒Ⓞ270-120HD	22	142 lbs	☉
	12'	68"	1W☒Ⓞ270-144HD	26	164 lbs	☉
	14'	86.75"	1W☒Ⓞ270-168HD	34	180 lbs	☉

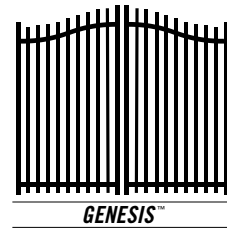
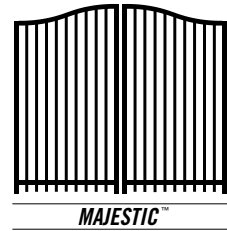
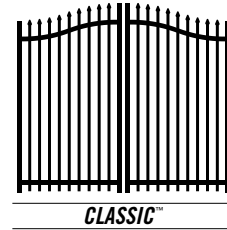

☒ = FENCE STYLES AVAILABLE | C = Classic M = Majestic G = Genesis

Ⓞ = COLOR OPTIONS AVAILABLE | B = Black N = Bronze

☉ = NON-STOCKED PRODUCT

For details, see Ameristar's Sales Policy in the catalog guide.

WARNING: Steel arched gates with EXTENDED PICKET BOTTOM exposure are NOT TO BE AUTOMATED! Extended picket bottom treatment does not meet ASTM standard F2200 for automated gates.

Notes: Genesis panels are packaged with BLACK picket plugs for black & bronze. Two gate leafs included for all double gates. Gate heights are nominal & gate widths are actual. For details about gate hardware that **MUST BE ORDERED SEPARATELY** for these gates, see the Montage Plus Arched Gate introduction at the beginning of this section.

Effective: 01/06/15

MONTAGE PLUS® | 2-RAIL DOUBLE SWING ARCHED GATES

4" AIR GAP | FLUSH BOTTOM | GATE HARDWARE SOLD SEPARATELY

	OPENING	LEAF WIDTH	ITEM NUMBER	PICKET QTY	WEIGHT	STOCKING
3' HEIGHT	7'	40"	1W☒Ⓞ234F-84HD	14	58 lbs	☉
	8'	49.5"	1W☒Ⓞ234F-96HD	18	68 lbs	☉
	10'	58.75"	1W☒Ⓞ234F-120HD	22	76 lbs	☉
	12'	68"	1W☒Ⓞ234F-144HD	26	86 lbs	☉
	14'	86.75"	1W☒Ⓞ234F-168HD	34	102 lbs	☉
3.5' HEIGHT	7'	40"	1W☒Ⓞ240F-84HD	14	64 lbs	☉
	8'	49.5"	1W☒Ⓞ240F-96HD	18	76 lbs	☉
	10'	58.75"	1W☒Ⓞ240F-120HD	22	86 lbs	☉
	12'	68"	1W☒Ⓞ240F-144HD	26	96 lbs	☉
	14'	86.75"	1W☒Ⓞ240F-168HD	34	112 lbs	☉
4' HEIGHT	7'	40"	1W☒Ⓞ246F-84HD	14	78 lbs	☉
	8'	49.5"	1W☒Ⓞ246F-96HD	18	84 lbs	☉
	10'	58.75"	1W☒Ⓞ246F-120HD	22	102 lbs	☉
	12'	68"	1W☒Ⓞ246F-144HD	26	118 lbs	☉
	14'	86.75"	1W☒Ⓞ246F-168HD	34	130 lbs	☉
5' HEIGHT	7'	40"	1W☒Ⓞ258F-84HD	14	98 lbs	☉
	8'	49.5"	1W☒Ⓞ258F-96HD	18	104 lbs	☉
	10'	58.75"	1W☒Ⓞ258F-120HD	22	122 lbs	☉
	12'	68"	1W☒Ⓞ258F-144HD	26	142 lbs	☉
	14'	86.75"	1W☒Ⓞ258F-168HD	34	154 lbs	☉
6' HEIGHT	7'	40"	1W☒Ⓞ270F-84HD	14	114 lbs	☉
	8'	49.5"	1W☒Ⓞ270F-96HD	18	122 lbs	☉
	10'	58.75"	1W☒Ⓞ270F-120HD	22	142 lbs	☉
	12'	68"	1W☒Ⓞ270F-144HD	26	164 lbs	☉
	14'	86.75"	1W☒Ⓞ270F-168HD	34	180 lbs	☉

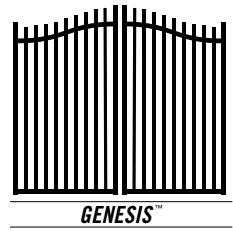
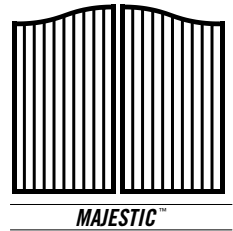
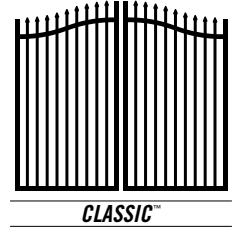

☒ = FENCE STYLES AVAILABLE | C = Classic M = Majestic G = Genesis

Ⓞ = COLOR OPTIONS AVAILABLE | B = Black N = Bronze

☉ = NON-STOCKED PRODUCT

For details, see Ameristar's Sales Policy in the catalog guide.

Notes: Genesis panels are packaged with BLACK picket plugs for black & bronze. Two gate leaves included for all double gates. Gate heights are nominal & gate widths are actual. For details about gate hardware that **MUST BE ORDERED SEPARATELY** for these gates, see the Montage Plus Arched Gate introduction at the beginning of this section.

Effective: 01/06/15

MONTAGE PLUS® | 3-RAIL DOUBLE SWING ARCHED GATES

4" AIR GAP | STANDARD BOTTOM | GATE HARDWARE SOLD SEPARATELY

	OPENING	LEAF WIDTH	ITEM NUMBER	PICKET QTY	WEIGHT	STOCKING
3' HEIGHT	7'	40"	1W☒⊗334-84HD	14	64 lbs	☉
	8'	49.5"	1W☒⊗334-96HD	18	76 lbs	☉
	10'	58.75"	1W☒⊗334-120HD	22	86 lbs	☉
	12'	68"	1W☒⊗334-144HD	26	98 lbs	☉
	14'	86.75"	1W☒⊗334-168HD	34	118 lbs	☉
3.5' HEIGHT	7'	40"	1W☒⊗340-84HD	14	72 lbs	☉
	8'	49.5"	1W☒⊗340-96HD	18	84 lbs	☉
	10'	58.75"	1W☒⊗340-120HD	22	96 lbs	☉
	12'	68"	1W☒⊗340-144HD	26	108 lbs	☉
	14'	86.75"	1W☒⊗340-168HD	34	128 lbs	☉
4' HEIGHT	7'	40"	1W☒⊗346-84HD	14	86 lbs	☉
	8'	49.5"	1W☒⊗346-96HD	18	92 lbs	☉
	10'	58.75"	1W☒⊗346-120HD	22	112 lbs	☉
	12'	68"	1W☒⊗346-144HD	26	130 lbs	☉
	14'	86.75"	1W☒⊗346-168HD	34	144 lbs	☉
5' HEIGHT	7'	40"	1W☒⊗358-84HD	14	104 lbs	☉
	8'	49.5"	1W☒⊗358-96HD	18	112 lbs	☉
	10'	58.75"	1W☒⊗358-120HD	22	132 lbs	☉
	12'	68"	1W☒⊗358-144HD	26	152 lbs	☉
	14'	86.75"	1W☒⊗358-168HD	34	168 lbs	☉
6' HEIGHT	7'	40"	1W☒⊗370-84HD	14	120 lbs	☉
	8'	49.5"	1W☒⊗370-96HD	18	130 lbs	☉
	10'	58.75"	1W☒⊗370-120HD	22	152 lbs	☉
	12'	68"	1W☒⊗370-144HD	26	178 lbs	☉
	14'	86.75"	1W☒⊗370-168HD	34	194 lbs	☉

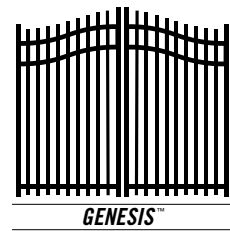
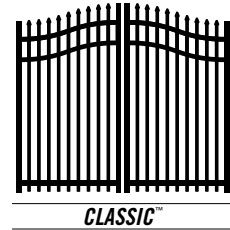

☒ = FENCE STYLES AVAILABLE | C = Classic M = Majestic G = Genesis

⊗ = COLOR OPTIONS AVAILABLE | B = Black N = Bronze

☉ = NON-STOCKED PRODUCT

For details, see Ameristar's Sales Policy in the catalog guide.

WARNING: Steel arched gates with EXTENDED PICKET BOTTOM exposure are NOT TO BE AUTOMATED! Extended picket bottom treatment does not meet ASTM standard F2200 for automated gates.

Notes: Genesis panels are packaged with BLACK picket plugs for black & bronze. Two gate leaves included for all double gates. Gate heights are nominal & gate widths are actual. For details about gate hardware that **MUST BE ORDERED SEPARATELY** for these gates, see the Montage Plus Arched Gate introduction at the beginning of this section.

Effective: 01/06/15

MONTAGE PLUS® | 3-RAIL DOUBLE SWING ARCHED GATES

4" AIR GAP | FLUSH BOTTOM | GATE HARDWARE SOLD SEPARATELY

	OPENING	LEAF WIDTH	ITEM NUMBER	PICKET QTY	WEIGHT	STOCKING
3' HEIGHT	7'	40"	1W☒☒334F-84HD	14	64 lbs	☉
	8'	49.5"	1W☒☒334F-96HD	18	76 lbs	☉
	10'	58.75"	1W☒☒334F-120HD	22	86 lbs	☉
	12'	68"	1W☒☒334F-144HD	26	98 lbs	☉
	14'	86.75"	1W☒☒334F-168HD	34	118 lbs	☉
3.5' HEIGHT	7'	40"	1W☒☒340F-84HD	14	72 lbs	☉
	8'	49.5"	1W☒☒340F-96HD	18	84 lbs	☉
	10'	58.75"	1W☒☒340F-120HD	22	96 lbs	☉
	12'	68"	1W☒☒340F-144HD	26	108 lbs	☉
	14'	86.75"	1W☒☒340F-168HD	34	128 lbs	☉
4' HEIGHT	7'	40"	1W☒☒346F-84HD	14	86 lbs	☉
	8'	49.5"	1W☒☒346F-96HD	18	92 lbs	☉
	10'	58.75"	1W☒☒346F-120HD	22	112 lbs	☉
	12'	68"	1W☒☒346F-144HD	26	130 lbs	☉
	14'	86.75"	1W☒☒346F-168HD	34	144 lbs	☉
4.5' HEIGHT	7'	40"	1WM☒☒354F-84HD*	14	98 lbs	☉
	8'	49.5"	1WM☒☒354F-96HD*	18	106 lbs	☉
	10'	58.75"	1WM☒☒354F-120HD*	22	130 lbs	☉
	12'	68"	1WM☒☒354F-144HD*	26	150 lbs	☉
	14'	86.75"	1WM☒☒354F-168HD*	34	164 lbs	☉
5' HEIGHT	7'	40"	1W☒☒358F-84HD	14	104 lbs	☉
	8'	49.5"	1W☒☒358F-96HD	18	112 lbs	☉
	10'	58.75"	1W☒☒358F-120HD	22	132 lbs	☉
	12'	68"	1W☒☒358F-144HD	26	152 lbs	☉
	14'	86.75"	1W☒☒358F-168HD	34	168 lbs	☉
6' HEIGHT	7'	40"	1W☒☒370F-84HD	14	120 lbs	☉
	8'	49.5"	1W☒☒370F-96HD	18	130 lbs	☉
	10'	58.75"	1W☒☒370F-120HD	22	152 lbs	☉
	12'	68"	1W☒☒370F-144HD	26	178 lbs	☉
	14'	86.75"	1W☒☒370F-168HD	34	194 lbs	☉

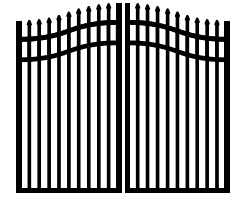

CLASSIC™

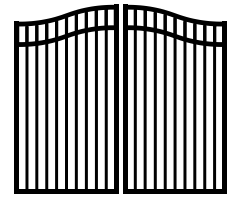

MAJESTIC™

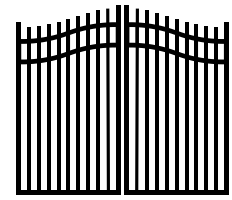

GENESIS™

* 4.5' flush bottom gates available in Majestic only

Notes: Genesis panels are packaged with BLACK picket plugs for black & bronze. Two gate leaves included for all double gates. Gate heights are nominal & gate widths are actual. For details about gate hardware that **MUST BE ORDERED SEPARATELY** for these gates, see the Montage Plus Arched Gate introduction at the beginning of this section.

Effective: 01/06/15

MONTAGE PLUS® | SINGLE SWING STEEL ESTATE GATE SPECIFICATIONS

2"sq x 12ga STEEL GATE ENDS | 1.4375"w x 1.5"h x 14ga RAILS | .75"sq x 14ga PICKETS | 8' - 12' NOMINAL OPENINGS

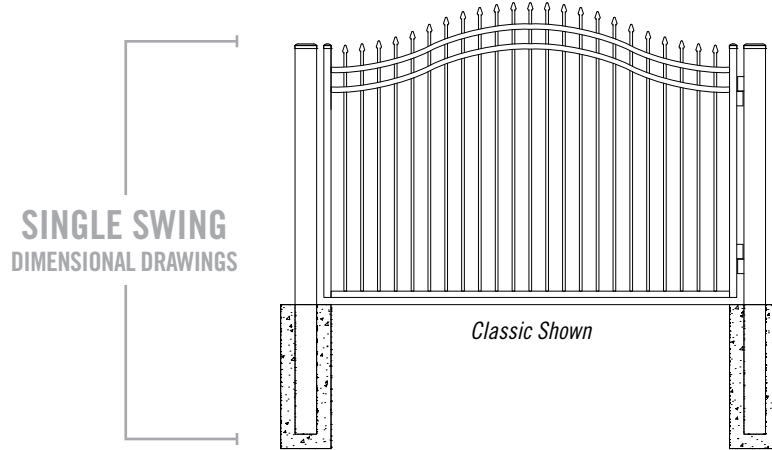

SINGLE SWING ESTATE
 HARDWARE KITS &
 POST INTERSPACES

OPENING	LEAF WIDTH*	SGBSX25 / SGBSX3 FORK LATCH / BOX HINGE KITS			CGBS-25 CGBS-3 / CGBS-4 COMMERCIAL HINGE WITH STRONG ARM			HGBS-25 HGBS-3 / HGBS-4 HEAVY COMMERCIAL HINGE KITS		
		HC	LC	P _S	HC	LC	P _S	HC	LC	P _S
8'	95.5"	2"	2"	99.5"	1"	3"	99.5"	1.25"	3"	99.75"
10'	114.75"	2"	2"	118.75"	1"	3"	118.75"	1.25"	3"	119"
12'	143"	2"	2"	147"	1"	3"	147"	1.25"	3"	147.25"

W = width* | HC = hinge clearance | LC = latch clearance | P_S = gate post spacing**
 * From outside to outside | ** From inside to inside

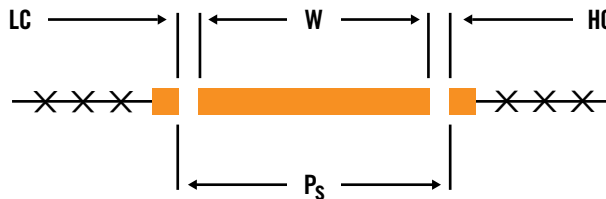

Effective: 01/06/15

MONTAGE PLUS® | DOUBLE SWING STEEL ESTATE GATE SPECIFICATIONS

2"sq x 12ga STEEL GATE ENDS | 1.4375"w x 1.5"h x 14ga RAILS | .75"sq x 14ga PICKETS | 16' - 24' NOMINAL OPENINGS

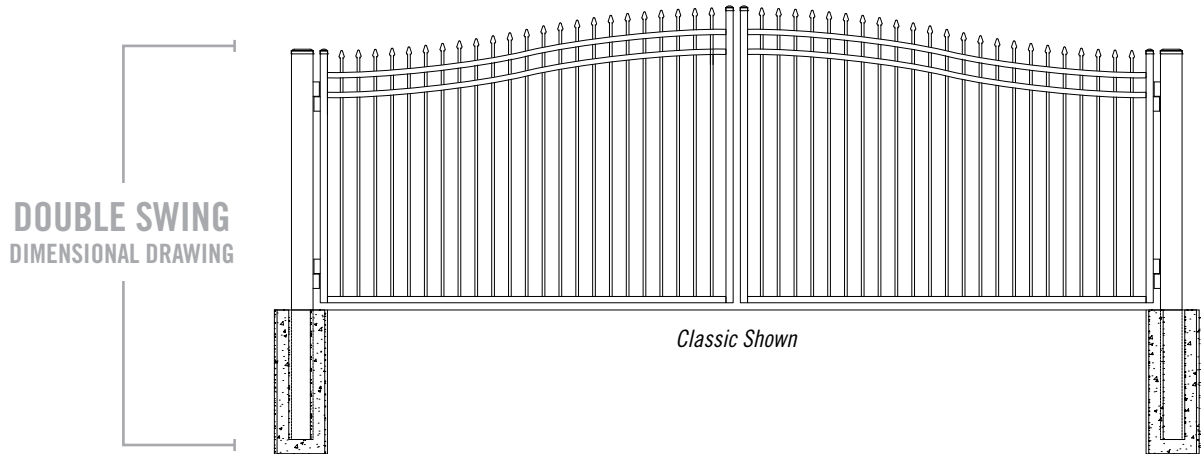

DOUBLE SWING
 ESTATE
 HARDWARE KITS &
 POST INTERSPACES

SGBDX FORK LATCH / BOX HINGE KITS | CGBD COMMERCIAL HINGE WITH STRONG ARM | HGBD HEAVY COMMERCIAL HINGE KITS

OPENING	LEAF WIDTH*	HC	LC	P _d	HC	LC	P _d	HC	LC	P _d
16'	95.5"	2"	2"	197"	1"	2"	195"	1.25"	2"	195.5"
18'	105.5"	2"	2"	217"	1"	2"	215"	1.25"	2"	215.5"
20'	114.75"	2"	2"	235.5"	1"	2"	233.5"	1.25"	2"	234"
22'	133.5"	2"	2"	273"	1"	2"	271"	1.25"	2"	271.5"
24'	143"	2"	2"	292"	1"	2"	290"	1.25"	2"	290.5"

W = width (x2)* | HC = hinge clearance (x2) | LC = latch clearance | P_d = gate post spacing**
 * From outside to outside | ** From inside to inside

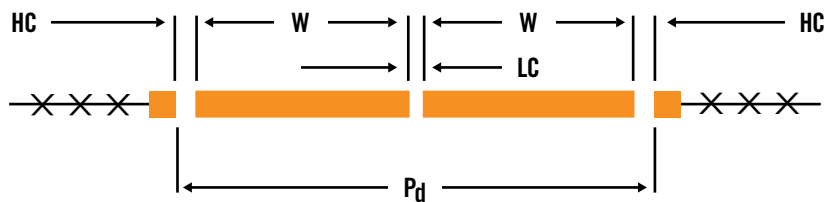

Effective: 01/06/15

TO PLACE YOUR ORDER CALL 888-333-3422 | VISIT AMERISTARFENCE.COM

AMERISTAR
 ASSA ABLOY

MONTAGE PLUS® | 3-RAIL SINGLE SWING ESTATE ENTRY GATES

4" AIR GAP | FLUSH BOTTOM | GATE HARDWARE SOLD SEPARATELY

	OPENING	LEAF WIDTH	ITEM NUMBER	PICKET QTY	WEIGHT	STOCKING
4' HEIGHT	8'	95.5"	1W☒ⓧ346F-96A	19	66 lbs	☉
	10'	114.75"	1W☒ⓧ346F-120A	23	75 lbs	☉
	12'	143"	1W☒ⓧ346F-144A	29	87 lbs	☉
4.5' HEIGHT	8'	95.5"	1WM☒ⓧ354F-96A*	19	70 lbs	☉
	10'	114.75"	1WM☒ⓧ354F-120A*	23	80 lbs	☉
	12'	143"	1WM☒ⓧ354F-144A*	29	92 lbs	☉
5' HEIGHT	8'	95.5"	1W☒ⓧ358F-96A	19	75 lbs	☉
	10'	114.75"	1W☒ⓧ358F-120A	23	85 lbs	☉
	12'	143"	1W☒ⓧ358F-144A	29	97 lbs	☉
6' HEIGHT	8'	95.5"	1W☒ⓧ370F-96A	19	84 lbs	☉
	10'	114.75"	1W☒ⓧ370F-120A	23	95 lbs	☉
	12'	143"	1W☒ⓧ370F-144A	29	108 lbs	☉

☒ = FENCE STYLES AVAILABLE | C = Classic M = Majestic G = Genesis

ⓧ = COLOR OPTIONS AVAILABLE | B = Black N = Bronze

☉ = NON-STOCKED PRODUCT

For details, see Ameristar's Sales Policy in the catalog guide.

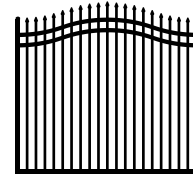

CLASSIC™

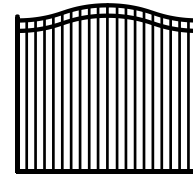

MAJESTIC™

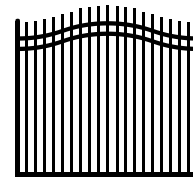

GENESIS™

* 4.5' flush bottom gates available in Majestic only

Notes: The above Steel Estate Entry Gates match Montage Plus 3 Rail Flush Bottom fence panels. Genesis panels are packaged with BLACK picket plugs for black & bronze. These steel estate entry gates are designed in COMPLIANCE WITH INDUSTRY STANDARDS FOR AUTOMATIC GATES AS OUTLINE BY UL325 & ASTM F2200

Effective: 01/06/15

MONTAGE PLUS® | 3-RAIL DOUBLE SWING ESTATE ENTRY GATES

4" AIR GAP | FLUSH BOTTOM | GATE HARDWARE SOLD SEPARATELY

	OPENING	LEAF WIDTH	ITEM NUMBER	PICKET QTY	WEIGHT	STOCKING
4' HEIGHT	16'	95.5"	1W☒Ⓞ346F-192HD	38	168 lbs	☉
	18'	105.5"	1W☒Ⓞ346F-216HD	42	176 lbs	☉
	20'	114.75"	1W☒Ⓞ346F-240HD	46	184 lbs	☉
	22'	133.5"	1W☒Ⓞ346F-264HD	54	192 lbs	☉
	24'	143"	1W☒Ⓞ346F-288HD	58	208 lbs	☉
4.5' HEIGHT	16'	95.5"	1WMⓄ354F-192HD*	38	194 lbs	☉
	18'	105.5"	1WMⓄ354F-216HD*	42	202 lbs	☉
	20'	114.75"	1WMⓄ354F-240HD*	46	210 lbs	☉
	22'	133.5"	1WMⓄ354F-264HD*	54	218 lbs	☉
	24'	143"	1WMⓄ354F-288HD*	58	224 lbs	☉
5' HEIGHT	16'	95.5"	1W☒Ⓞ358F-192HD	38	198 lbs	☉
	18'	105.5"	1W☒Ⓞ358F-216HD	42	206 lbs	☉
	20'	114.75"	1W☒Ⓞ358F-240HD	46	214 lbs	☉
	22'	133.5"	1W☒Ⓞ358F-264HD	54	222 lbs	☉
	24'	143"	1W☒Ⓞ358F-288HD	58	228 lbs	☉
6' HEIGHT	16'	95.5"	1W☒Ⓞ370F-192HD	38	226 lbs	☉
	18'	105.5"	1W☒Ⓞ370F-216HD	42	230 lbs	☉
	20'	114.75"	1W☒Ⓞ370F-240HD	46	238 lbs	☉
	22'	133.5"	1W☒Ⓞ370F-264HD	54	246 lbs	☉
	24'	143"	1W☒Ⓞ370F-288HD	58	252 lbs	☉

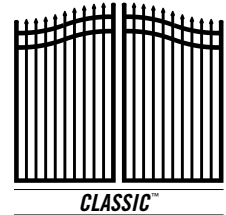

CLASSIC™

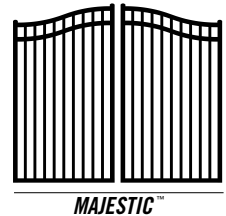

MAJESTIC™

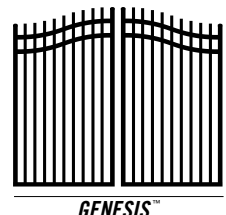

GENESIS™

☒ = FENCE STYLES AVAILABLE | C = Classic M = Majestic G = Genesis

Ⓞ = COLOR OPTIONS AVAILABLE | B = Black N = Bronze

☉ = NON-STOCKED PRODUCT

For details, see Ameristar's Sales Policy in the catalog guide.

* 4.5' flush bottom gates available in Majestic only

Notes: The above Steel Estate Entry Gates match Montage Plus 3 Rail Flush Bottom fence panels. Genesis panels are packaged with BLACK picket plugs for black & bronze. These steel estate entry gates are designed in COMPLIANCE WITH INDUSTRY STANDARDS FOR AUTOMATIC GATES AS OUTLINE BY UL325 & ASTM F2200. Two gate leaves included for all double gates. Gate heights are nominal & gate widths are actual.

Effective: 01/06/15

MONTAGE PLUS® | 4-RAIL SINGLE SWING ESTATE ENTRY GATES

4" AIR GAP | FLUSH BOTTOM | GATE HARDWARE SOLD SEPARATELY

	OPENING	LEAF WIDTH	ITEM NUMBER	PICKET QTY	WEIGHT	STOCKING
4' HEIGHT	8'	95.5"	1W☒ⓧ446F-96A	19	74 lbs	☉
	10'	114.75"	1W☒ⓧ446F-120A	23	86 lbs	☉
	12'	143"	1W☒ⓧ446F-144A	29	100 lbs	☉
4.5' HEIGHT	8'	95.5"	1WMⓂ454F-96A*	19	79 lbs	☉
	10'	114.75"	1WMⓂ454F-120A*	23	91 lbs	☉
	12'	143"	1WMⓂ454F-144A*	29	105 lbs	☉
5' HEIGHT	8'	95.5"	1W☒ⓧ458F-96A	19	83 lbs	☉
	10'	114.75"	1W☒ⓧ458F-120A	23	96 lbs	☉
	12'	143"	1W☒ⓧ458F-144A	29	110 lbs	☉
6' HEIGHT	8'	95.5"	1W☒ⓧ470F-96A	19	92 lbs	☉
	10'	114.75"	1W☒ⓧ470F-120A	23	106 lbs	☉
	12'	143"	1W☒ⓧ470F-144A	29	121 lbs	☉

☒ = FENCE STYLES AVAILABLE | C = Classic M = Majestic G = Genesis

ⓧ = COLOR OPTIONS AVAILABLE | B = Black N = Bronze

☉ = NON-STOCKED PRODUCT

For details, see Ameristar's Sales Policy in the catalog guide.

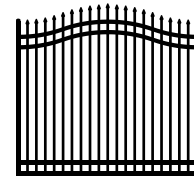

CLASSIC™

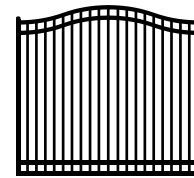

MAJESTIC™

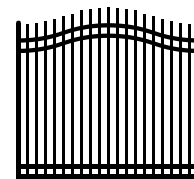

GENESIS™

* 4.5' flush bottom gates available in Majestic only

Notes: Genesis panels are packaged with BLACK picket plugs for black & bronze. These steel estate entry gates are designed in COMPLIANCE WITH INDUSTRY STANDARDS FOR AUTOMATIC GATES AS OUTLINE BY UL325 & ASTM F2200. Third rail from the top on the above Steel Estate Entry Gates matches Montage Plus 3-Rail extended picket fence panels.

Effective: 01/06/15

MONTAGE PLUS® | 4-RAIL DOUBLE SWING ESTATE ENTRY GATES

4" AIR GAP | FLUSH BOTTOM | GATE HARDWARE SOLD SEPARATELY

	OPENING	LEAF WIDTH	ITEM NUMBER	PICKET QTY	WEIGHT	STOCKING
4' HEIGHT	16'	95.5"	1W☒⊗446F-192HD	38	140 lbs	☉
	18'	105.5"	1W☒⊗446F-216HD	42	150 lbs	☉
	20'	114.75"	1W☒⊗446F-240HD	46	160 lbs	☉
	22'	133.5"	1W☒⊗446F-264HD	54	172 lbs	☉
	24'	143"	1W☒⊗446F-288HD	58	183 lbs	☉
4.5' HEIGHT	16'	95.5"	1WM⊗454F-192HD*	38	147 lbs	☉
	18'	105.5"	1WM⊗454F-216HD*	42	158 lbs	☉
	20'	114.75"	1WM⊗454F-240HD*	46	168 lbs	☉
	22'	133.5"	1WM⊗454F-264HD*	54	180 lbs	☉
	24'	143"	1WM⊗454F-288HD*	58	191 lbs	☉
5' HEIGHT	16'	95.5"	1W☒⊗458F-192HD	38	155 lbs	☉
	18'	105.5"	1W☒⊗458F-216HD	42	165 lbs	☉
	20'	114.75"	1W☒⊗458F-240HD	46	176 lbs	☉
	22'	133.5"	1W☒⊗458F-264HD	54	189 lbs	☉
	24'	143"	1W☒⊗458F-288HD	58	199 lbs	☉
6' HEIGHT	16'	95.5"	1W☒⊗470F-192HD	38	170 lbs	☉
	18'	105.5"	1W☒⊗470F-216HD	42	181 lbs	☉
	20'	114.75"	1W☒⊗470F-240HD	46	192 lbs	☉
	22'	133.5"	1W☒⊗470F-264HD	54	205 lbs	☉
	24'	143"	1W☒⊗470F-288HD	58	216 lbs	☉

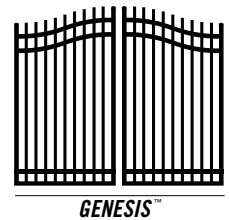
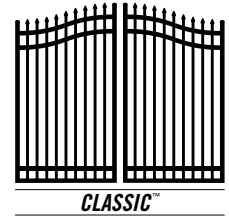

☒ = FENCE STYLES AVAILABLE | **C** = Classic **M** = Majestic **G** = Genesis

⊗ = COLOR OPTIONS AVAILABLE | **B** = Black **N** = Bronze

☉ = NON-STOCKED PRODUCT

For details, see Ameristar's Sales Policy in the catalog guide.

* 4.5' flush bottom gates available in Majestic only

Notes: Genesis panels are packaged with BLACK picket plugs for black & bronze. These steel estate entry gates are designed in COMPLIANCE WITH INDUSTRY STANDARDS FOR AUTOMATIC GATES AS OUTLINE BY UL325 & ASTM F2200. Third rail from the top on the above Steel Estate Entry Gates matches Montage Plus. 3-Rail extended picket fence panels. Two gate leaves included for all double gates. Gate heights are nominal & gate widths are actual.

Effective: 01/06/15

MONTAGE PLUS® | GATE ENDS

1.75" x 14ga | GATES FABRICATED BY WELDING GATE ENDS TO PANEL REMNANTS ARE EXCLUDED FROM THE WARRANTY

SIZE	ITEM NUMBER	BOX QTY	WEIGHT
1.75" x 34"	1Hⓧ234	8	2.90 lbs
1.75" x 40"	1Hⓧ240	8	3.45 lbs
1.75" x 46"	1Hⓧ246	8	3.83 lbs
1.75" x 58"	1Hⓧ258	8	4.00 lbs
1.75" x 70"	1Hⓧ270	8	4.95 lbs
1.75" x 71"	1Hⓧ271	8	5.00 lbs

ⓧ = COLOR OPTIONS AVAILABLE | **B** = Black | **N** = Bronze

Notes: 1.75" sq. pressed steel post caps are included in box for each gate end

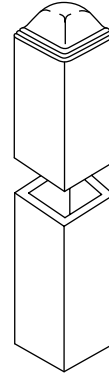

Effective: 01/06/15

Effective: 01/06/15

TO PLACE YOUR ORDER CALL 888-333-3422 | VISIT AMERISTARFENCE.COM

AMERISTAR®
ASSA ABLOY

Effective: 01/06/15